

## ▶ 定格総荷重

- 定格総荷重とは、水平堅土上における転倒荷重の78%以内で、フックブロック、玉掛用ワイヤロープ等のつり具の質量を含んだ値です。
- 作業半径とはクレーン旋回中心よりつり上荷重の重心までの水平距離を意味します。
- 実際につり上げ得る荷重は定格総荷重から（主フック+玉掛用ワイヤロープ等のつり具）の質量を差し引いた値になります。ただし、中間ブームにブームネスティングローラ（オプション）が取付いた状態で作業する場合の定格総荷重の最大値は、使用するフックの呼称容量から使用するフック質量とブームネスティングローラ質量（下表）を差し引いた値とします。

タワー

タワー長さ(m)	36.6	39.7	42.7	45.8	48.8	51.9	54.9	58.0	61.0	64.1
差し引く値(t)	0.1	0.1	0.2	0.2	0.2	0.2	0.2	0.2	0.2	0.2

- 定格総荷重をつる場合にも風の影響、地盤の状態、作業速度その他安全作業に有害な状況がある時はオペレータは荷重の軽減、作業速度を遅くするなど状況に応じた判断をする責任があります。
- 表中の空欄の個所では作業を行うことができません。
- クレーン作業中はガントリを最高位置に立ててください。
- すべてのタワー（ジブ）長さにおける中間タワーブーム（ジブ）の構成は取扱説明書の指示を厳守してください。
- ジブ長さ27.4mにてボールフックの使用はできません。
- 64.1mタワーの自立、降下の際には、クローラの前端に敷板（ブロック）を敷いて下さい。

△ 操作ミスなどによるつり荷の落下を防ぐため、クレーン作業では自由降下（フリーフォール）作業は行わないでください。

- 巻き上げロープ巻掛本数に対する最大巻上荷重とフックの質量

フック呼称	35t		ボールフック
最大巻上荷重 (t)	1本掛	13.5	13.5
	2本掛	25.0	-
フック質量	0.90t		0.45t

※ジブ長さ27.4mでのボールフックの使用はできません。

## ▶ フック巻上限界 (単位:m)

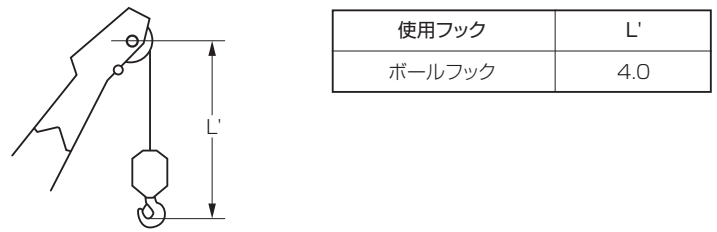
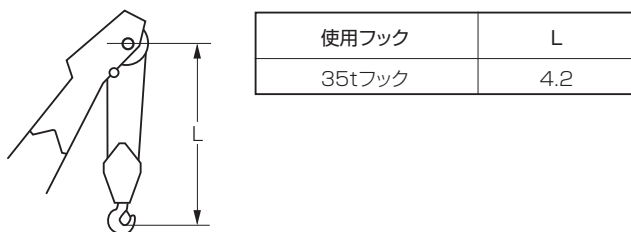

## ▶ タワー長さ 36.6m

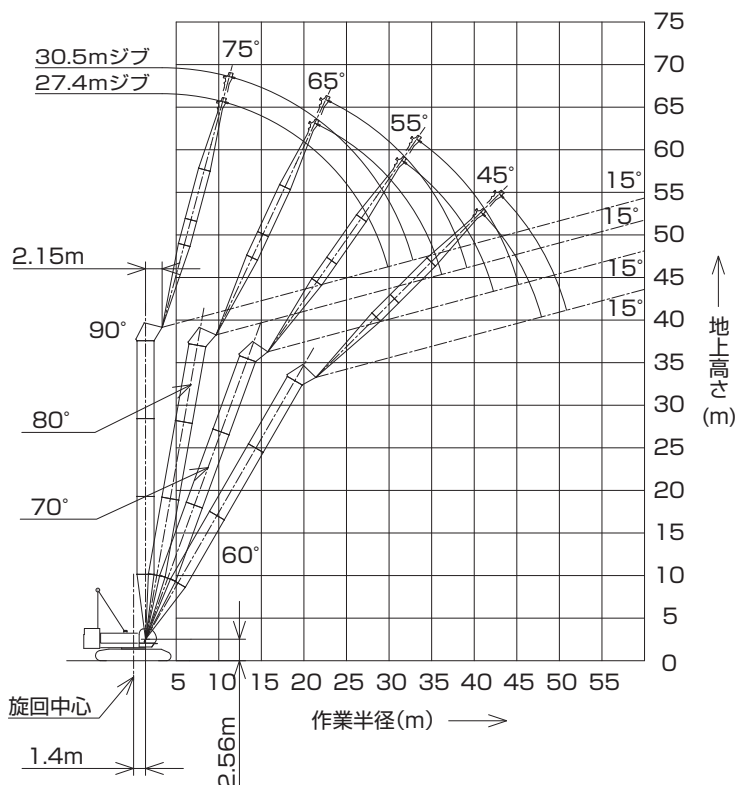

(単位:t)

タワー長さm	36.6							タワー長さm	
ジブ長さm	27.4			30.5				ジブ長さm	
タワー角度	90°	80°	70°	60°	90°	80°	70°	60°	タワー角度
作業半径(m)	10.0	25.0/10.9m			25/11.7m				10.0
	12.0	25.0			25.0				12.0
	14.0	25.0			25.0				14.0
	16.0	25.0			25.0				16.0
	18.0	25.0			24.2				18.0
	20.0	24.2	23.4/21.7m		23.5				20.0
	22.0	23.2	23.2		22.7	21.9/23.0m			22.0
	24.0	21.0	21.0		21.0	21.0			24.0
	26.0	18.6	18.6		18.6	18.6			26.0
	28.0	16.0	16.8		16.7	16.7			28.0
	30.0	11.2/23.9m	15.2	14.1/31.9m	15.1	15.1			30.0
	32.0		14.0	14.0	12.0	13.9	13.0/33.7m		32.0
	34.0		12.8	12.8	10.6/32.8m	12.7	12.7		34.0
	36.0		11.8	11.8		11.7	11.7		36.0
	38.0		11.8/36.2m	11.1		11.0	11.0		38.0
	40.0			10.4	10.0/41.2m	10.6/39.2m	10.3		40.0
42.0			9.7	9.7		9.6	9.2/43.3m	42.0	
44.0				9.6/42.3m	9.1	9.0	9.0	44.0	
46.0				8.6		8.7/45.2m	8.5	46.0	
48.0				8.2			8.1	48.0	
50.0					8.2/47.9m		7.7	50.0	
52.0							7.6/50.8m	52.0	

※表中の太線で囲まれた部分は、ブーム等の強度によって定められた値です。

# ▶タワー長さ 39.7m

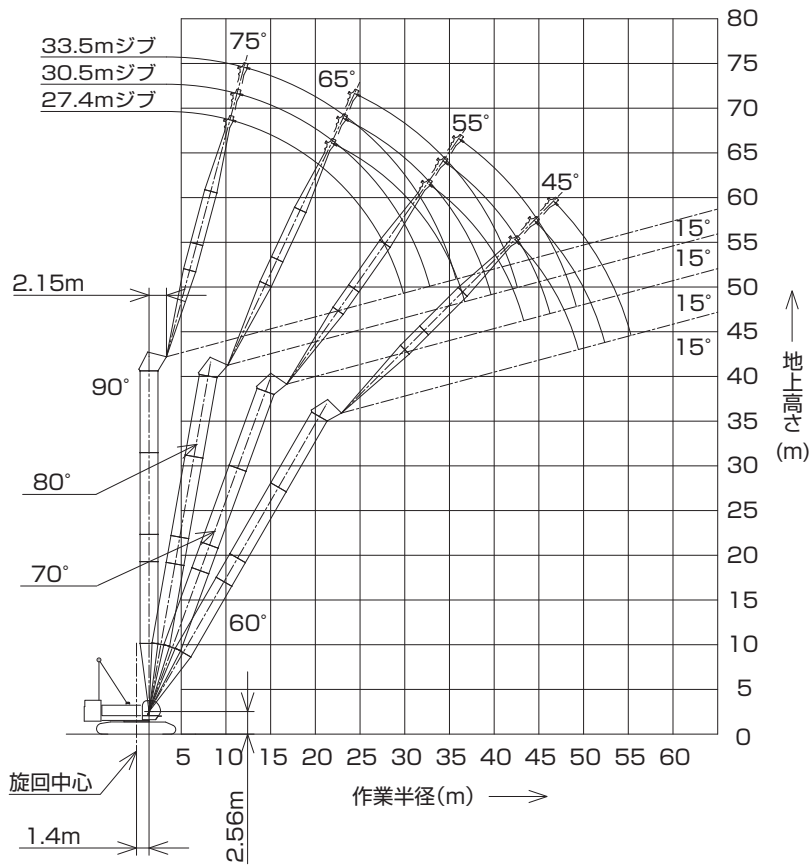

(単位:t)

タワー長さm	39.7												タワー長さm
ジブ長さm	27.4				30.5				33.5				ジブ長さm
タワー角度	90°	80°	70°	60°	90°	80°	70°	60°	90°	80°	70°	60°	タワー角度
作業半径(m)	10.0	25.0/10.9m			25.0/11.7m								10.0
	12.0	25.0			25.0				25.0/12.5m				12.0
	14.0	25.0			25.0				25.0				14.0
	16.0	25.0			25.0				24.2				16.0
	18.0	25.0			24.2				23.4				18.0
	20.0	24.2			23.5				22.6				20.0
	22.0	23.2	22.8/22.3m		22.7	21.4/23.6m			21.8				22.0
	24.0	20.9	20.9		21.0	20.9			21.0	20.2/24.8m			24.0
	26.0	18.5	18.6		18.6	18.6			18.8	18.6			26.0
	28.0	16.1	16.8		16.7	16.7			16.7	16.7			28.0
	30.0	11.2/29.9m	15.2		15.1	15.1			15.3	15.1			30.0
	32.0		14.0	13.4/33.0m		12.0	13.9		14.0	13.9			32.0
	34.0		12.8	12.8		10.6/32.8m	12.7	12.4/34.7m	12.0	12.7			34.0
	36.0		11.8	11.8			11.7	11.7	9.2/35.8m	11.7	11.5/36.5m		36.0
	38.0		11.5/36.7m	11.1			11.0	11.0		11.0	11.0		38.0
	40.0			10.4			10.4/39.7m	10.3		10.2	10.3		40.0
	42.0			9.7	9.5/42.7m			9.6		9.6	9.6		42.0
	44.0			9.3/43.3m	9.1			9.0	8.7/44.9m	9.4/42.6m	9.0		44.0
46.0				8.6			8.5	8.5		8.4	8.2/47.0m	46.0	
48.0				8.2			8.4/46.3m	8.1		8.0	8.0	48.0	
50.0				8.0/49.4m				7.7		7.7/49.2m	7.6	50.0	
52.0								7.3			7.2	52.0	
54.0								7.2/52.4m			6.8	54.0	
56.0											6.6/55.3m	56.0	

※表中の太線で囲まれた部分は、ブーム等の強度によって定められた値です。

# ▶タワー長さ 42.7m

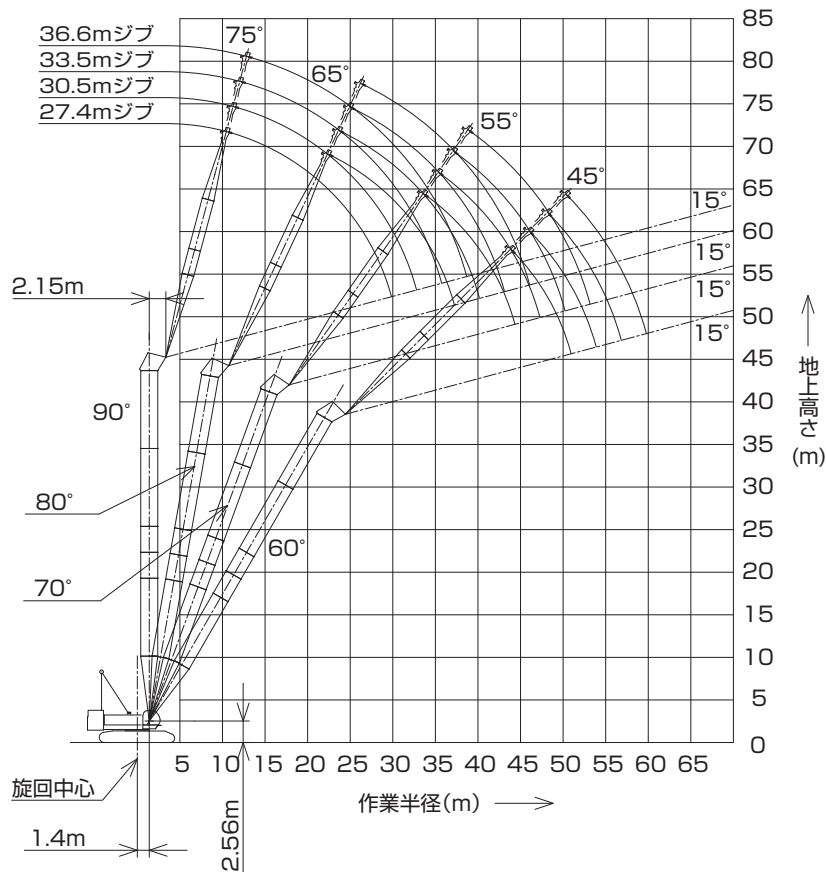

(単位:t)

タワー長さm	42.7																タワー長さm
ジブ長さm	27.4				30.5				33.5				36.6				ジブ長さm
タワー角度	90°	80°	70°	60°	90°	80°	70°	60°	90°	80°	70°	60°	90°	80°	70°	60°	タワー角度
作業半径(m)	10.0	25.0/10.9m			25.0/11.7m												10.0
	12.0	25.0			25.0				25.0/12.5m				23.9/13.3m				12.0
	14.0	25.0			25.0				25.0				23.6				14.0
	16.0	25.0			25.0				24.2				22.9				16.0
	18.0	25.0			24.2				23.4				22.2				18.0
	20.0	24.2			23.5				22.6				21.4				20.0
	22.0	23.2	22.3/22.8m		22.7				21.8				20.7				22.0
	24.0	20.9	20.9		21.0	20.9/24.1m			21.0	19.6/25.4m			19.9				24.0
	26.0	18.5	18.6		18.6	18.6			18.8	18.6			18.8	18.2/26.7m			26.0
	28.0	16.3	16.8		16.7	16.7			16.7	16.7			16.8	16.7			28.0
	30.0	11.3/29.9m	15.2		15.1	15.1			15.3	15.1			15.2	15.0			30.0
	32.0		14.0		12.0	13.9			14.0	13.9			14.0	13.8			32.0
	34.0		12.8	12.8/34.0m	10.6/32.8m	12.7	11.8/35.8m		12.1	12.7			12.8	12.6			34.0
	36.0		11.8	11.8		11.7	11.7		9.2/35.8m	11.7			11.7	11.6			36.0
	38.0		11.4/37.3m	11.1		11.0	11.0			11.0	11.0/38.0m		9.3	10.9	10.4/39.3m		38.0
	40.0			10.4		10.3	10.3			10.2	10.3		8.7/38.7m	10.1	10.1		40.0
	42.0			9.7		10.2/40.2m	9.6			9.6	9.6			9.5	9.5		42.0
	44.0			9.1	9.0/44.2m		9.0			9.3/43.2m	9.0			8.9	8.9		44.0
	46.0			8.9/44.4m	8.6		8.5	8.4/46.4m			8.4			8.4	8.3		46.0
	48.0				8.2		8.2/47.3m	8.1			7.9	7.9/48.5m		8.3/46.1m	7.8		48.0
50.0				7.8			7.7			7.5	7.6			7.4	7.3/50.7m	50.0	
52.0				7.6/51.0m			7.3				7.5/50.2m	7.2		7.0	7.1	52.0	
54.0							6.9/53.9m					6.8			6.7/53.2m	54.0	
56.0												6.4			6.3	56.0	
58.0												6.3/56.8m			6.0	58.0	
60.0															5.7/59.8m	60.0	

※表中の太線で囲まれた部分は、ブーム等の強度によって定められた値です。

# ▶タワー長さ 45.8m

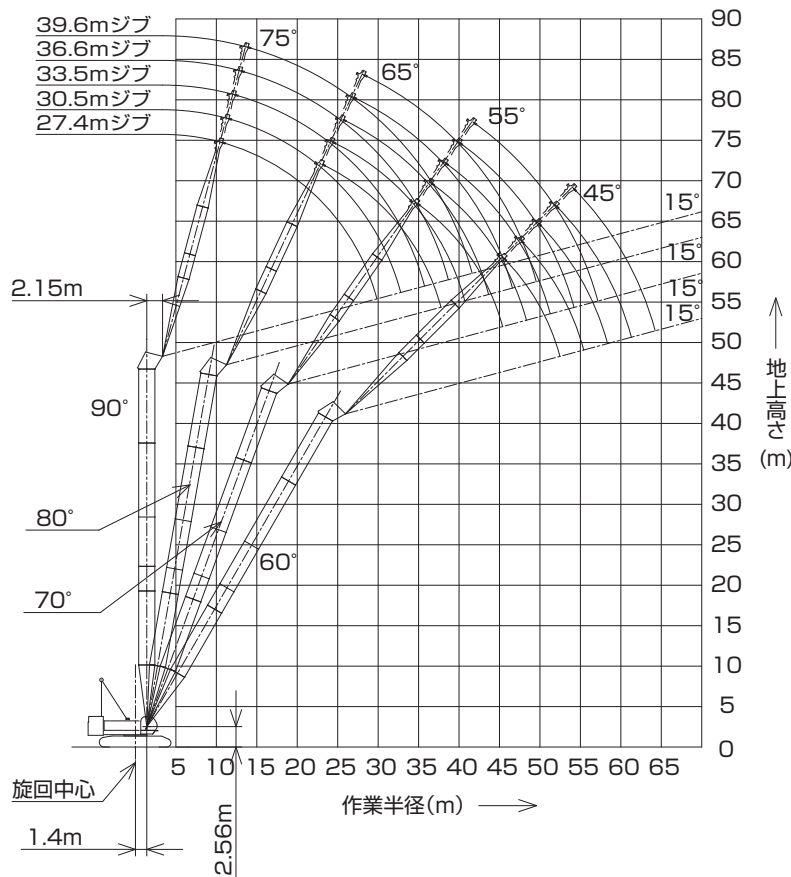

(単位:t)

タワー長さm		45.8																タワー長さm					
ジブ長さm		27.4				30.5				33.5				36.6				39.6				ジブ長さm	
タワー角度		90°	80°	70°	60°	90°	80°	70°	60°	90°	80°	70°	60°	90°	80°	70°	60°	90°	80°	70°	60°	タワー角度	
作業半径 (m)	10.0	25.0/10.9m				25.0/11.7m																10.0	
	12.0	25.0				25.0				25.0/12.5m				23.9/13.3m							22.0/14.1m	12.0	
	14.0	25.0				25.0				24.2				22.9							21.4	14.0	
	16.0	25.0				25.0				24.2				22.2							20.8	16.0	
	18.0	25.0				24.2				23.4				21.4							20.2	18.0	
	20.0	24.2				23.5				22.6				21.4							20.2	20.0	
	22.0	23.2	21.7/23.3m			22.7				21.8				20.7							19.6	22.0	
	24.0	20.9	20.9			21.0	20.3/24.5m			21.0	18.7/25.9m			19.9							19.0	24.0	
	26.0	18.5	18.6			18.6	18.6			18.8	18.6			18.8	17.6/27.2m					18.3	16.3/28.5m	26.0	
	28.0	16.3	16.8			16.7	16.7			16.7	16.7			16.8	16.7				16.8	16.8	16.8	16.3/28.5m	28.0
	30.0	11.3/23.9m	15.2			15.1	15.1			15.3	15.1			15.2	15.0				15.2	14.9	15.2	14.9	30.0
	32.0		14.0			12.0	13.9			14.0	13.9			14.0	13.8				14.0	13.7	14.0	13.7	32.0
	34.0		12.8	12.3/35.0m		10.6/32.8m	12.7			12.1	12.7			12.8	12.6				12.8	12.5	12.8	12.5	34.0
	36.0		11.8	11.8		11.7	11.5/36.8m			9.2/35.8m	11.7			11.6	11.6				11.8	11.5	11.8	11.5	36.0
	38.0		11.2/37.9m	11.1		11.0	11.0			11.0	10.9/38.5m			9.3	10.9				10.8	10.8	10.8	10.8	38.0
	40.0			10.4		10.3	10.3			10.2	10.3			8.7/38.7m	10.1	10.1/40.3m			9.3	10.0	9.3	10.0	40.0
	42.0			9.7			9.6			9.6	9.6				9.5	9.5			7.7/41.7m	9.4	9.4	9.4	42.0
	44.0			9.1	8.6/45.8m		9.0			9.1/43.7m	9.0			8.9	8.9				8.8	8.7	8.8	8.7	44.0
	46.0			8.8/45.4m	8.6		8.5	8.1/47.9m			8.4			8.4	8.3				8.2	8.1	8.2	8.1	46.0
	48.0				8.2		8.1	8.1			7.9			8.2/46.6m	7.8				7.6	7.6	7.6	7.6	48.0
50.0				7.8		8.1/48.3m	7.7			7.5	7.6/50.1m			7.4				7.2	7.2	7.2	7.2	50.0	
52.0				7.4			7.3			7.3/51.3m	7.2			7.0	7.0/52.2m				6.8		6.8	52.0	
54.0				7.3/52.5m			6.9				6.8			6.6	6.7			6.4	6.4	6.4	6.3/54.4m	54.0	
56.0							6.7/55.4m				6.4			6.6/54.2m	6.3			6.1	6.1	6.1	6.1	56.0	
58.0											6.1				6.0			5.9/57.2m	5.8	5.8	5.8	58.0	
60.0											6.0/58.4m				5.7				5.5	5.5	5.5	60.0	
62.0															5.5/61.3m				5.3	5.3	5.3	62.0	
64.0																			5.1	5.1	5.1	64.0	
66.0																					5.0/64.3m	66.0	

※表中の太線で囲まれた部分は、ブーム等の強度によって定められた値です。

# ▶タワー長さ 48.8m

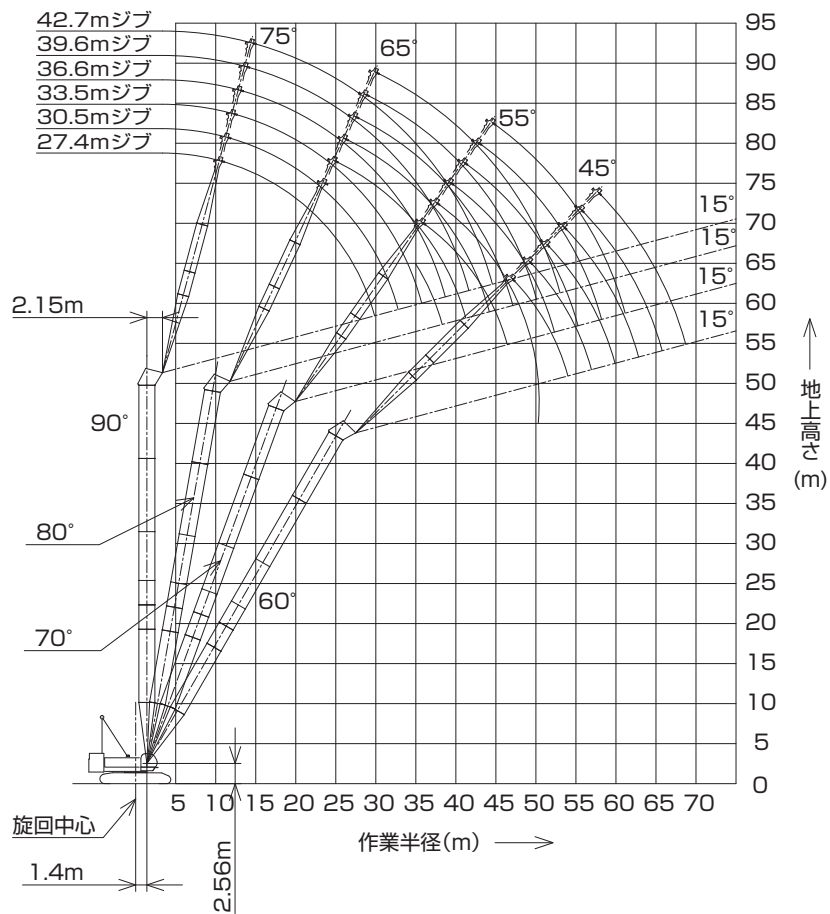

(単位:t)

タワー長さm	48.8								タワー長さm
ジブ長さm	27.4				30.5				ジブ長さm
タワー角度	90°	80°	70°	60°	90°	80°	70°	60°	タワー角度
作業半径(m)	10.0	25.0/10.9m			25.0/11.7m				10.0
	12.0	25.0			25.0				12.0
	14.0	25.0			25.0				14.0
	16.0	25.0			25.0				16.0
	18.0	25.0			24.2				18.0
	20.0	24.2			23.5				20.0
	22.0	23.2			22.7				22.0
	24.0	20.9			21.0				24.0
	26.0	18.5			19.7/25.1m		18.6		26.0
	28.0	16.3			16.7		16.7		28.0
	30.0	11.3/29.9m			15.1		15.1		30.0
	32.0	14.0			12.0		13.9		32.0
	34.0	12.8			10.6/32.8m		12.7		34.0
	36.0	11.8			11.8/36.1m		11.7		36.0
	38.0	11.1			11.1		11.0		38.0
	40.0	11.0/38.3m			10.4		10.3		40.0
	42.0	9.7			9.9/41.3m		9.6		42.0
	44.0	9.1			9.0		9.0		44.0
	46.0	8.6			8.3/47.3m		8.5		46.0
	48.0	8.5/46.4m			8.2		8.0		48.0
50.0	7.8			7.7/49.4m		7.7		50.0	
52.0	7.4			7.3		7.3		52.0	
54.0	7.0/54.0m			6.9		6.9		54.0	
56.0	6.5			6.5		6.5		56.0	
58.0	6.4/56.9m			6.4/56.9m		6.4/56.9m		58.0	

※表中の太線で囲まれた部分は、ブーム等の強度によって定められた値です。

(単位:t)

タワー長さm	48.8								タワー長さm
ジブ長さm	33.5				36.6				ジブ長さm
タワー角度	90°	80°	70°	60°	90°	80°	70°	60°	タワー角度
12.0	25.0/12.5m				23.9/13.3m				12.0
14.0	25.0				23.6				14.0
16.0	24.2				22.9				16.0
18.0	23.4				22.2				18.0
20.0	22.6				21.4				20.0
22.0	21.8				20.7				22.0
24.0	21.0				19.9				24.0
26.0	18.8	18.4/26.4m			18.8	17.0/27.7m			26.0
28.0	16.7	16.7			16.8	16.7			28.0
30.0	15.3	15.1			15.2	15.0			30.0
32.0	14.0	13.9			14.0	13.8			32.0
34.0	12.1	12.7			12.8	12.6			34.0
36.0	9.2/35.8m	11.7			11.6	11.6			36.0
38.0		11.0	10.3/39.6m		9.3	10.9			38.0
40.0		10.2	10.2		8.7/38.7m	10.1	9.6/41.3m		40.0
42.0		9.6	9.5			9.5	9.4		42.0
44.0		8.9	8.9			8.9	8.8		44.0
46.0		8.9/44.2m	8.4			8.4	8.3		46.0
48.0			7.9			8.1/47.2m	7.8		48.0
50.0			7.5	7.3/51.6m			7.4		50.0
52.0			7.1	7.2			7.0	6.8/53.7m	52.0
54.0			7.1/52.3m	6.8			6.6	6.7	54.0
56.0				6.4			6.4/55.3m	6.3	56.0
58.0				6.1				6.0	58.0
60.0				5.8/59.9m				5.7	60.0
62.0								5.4	62.0
64.0								5.3/62.8m	64.0

※表中の太線で囲まれた部分は、ブーム等の強度によって定められた値です。

(単位:t)

タワー長さm	48.8								タワー長さm
ジブ長さm	39.6				42.7				ジブ長さm
タワー角度	90°	80°	70°	60°	90°	80°	70°	60°	タワー角度
14.0	22.0/14.1m				20.0/14.9m				14.0
16.0	21.4				19.7				16.0
18.0	20.8				19.2				18.0
20.0	20.2				18.6				20.0
22.0	19.6				18.1				22.0
24.0	19.0				17.5				24.0
26.0	18.3				17.0				26.0
28.0	16.8	15.8/29.0m			16.5				28.0
30.0	15.2	14.9			15.2	14.7/30.3m			30.0
32.0	14.0	13.7			14.0	13.6			32.0
34.0	12.8	12.5			12.8	12.4			34.0
36.0	11.8	11.5			11.8	11.4			36.0
38.0	10.8	10.8			10.9	10.6			38.0
40.0	9.3	10.0			9.8	9.8			40.0
42.0	7.7/41.7m	9.4	9.0/43.1m		8.9	9.2			42.0
44.0		8.8	8.7		7.2	8.6	8.3/44.8m		44.0
46.0		8.2	8.1		6.8/44.6m	8.0	7.9		46.0
48.0		7.6	7.6			7.4	7.4		48.0
50.0		7.2	7.2			7.0	7.0		50.0
52.0		7.1/50.1m	6.8			6.6	6.6		52.0
54.0			6.4	6.1/55.9m		6.4/53.0m	6.2		54.0
56.0			6.1	6.1			5.9		56.0
58.0			5.8	5.8			5.6	5.6/58.1m	58.0
60.0			5.8/58.2m	5.5			5.4	5.4	60.0
62.0				5.3			5.3/61.2m	5.2	62.0
64.0				5.1				5.0	64.0
66.0				4.9/65.8m				4.8	66.0
68.0								4.6	68.0
70.0								4.5/68.7m	70.0

※表中の太線で囲まれた部分は、ブーム等の強度によって定められた値です。

# ▶タワー長さ 51.9m

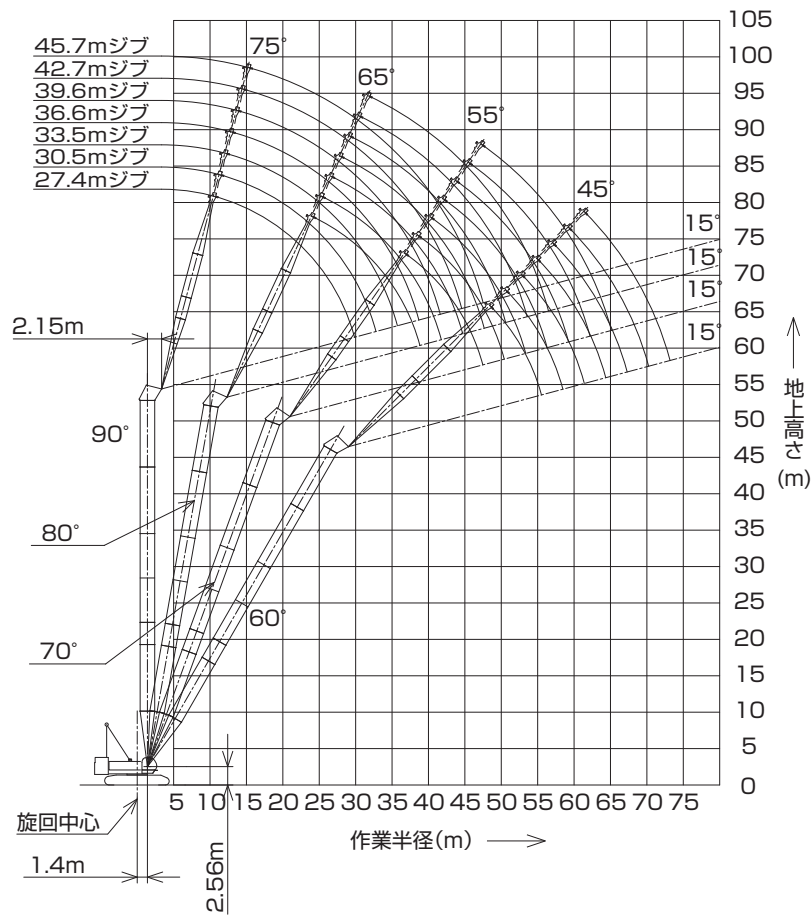

(単位:t)

タワー長さm	51.9												タワー長さm
ジブ長さm	27.4				30.5				33.5				ジブ長さm
タワー角度	90°	80°	70°	60°	90°	80°	70°	60°	90°	80°	70°	60°	タワー角度
作業半径(m)	10.0	25.0/10.9m			25.0/11.7m								10.0
	12.0	25.0			25.0				25.0/12.5m				12.0
	14.0	25.0			25.0				25.0				14.0
	16.0	25.0			25.0				24.2				16.0
	18.0	25.0			24.2				23.4				18.0
	20.0	24.2			23.5				22.6				20.0
	22.0	23.2			22.7				21.8				22.0
	24.0	20.9	20.6/24.4m		21.0	19.0/25.7m			21.0				24.0
	26.0	18.5	18.6		18.6	18.6			18.8	17.8/27.0m			26.0
	28.0	16.3	16.8		16.7	16.7			16.7	16.7			28.0
	30.0	11.3/29.9m	15.2		15.1	15.1			15.3	15.1			30.0
	32.0		14.0		12.0	13.9			14.0	13.9			32.0
	34.0		12.8		10.6/32.8m	12.7			12.1	12.7			34.0
	36.0		11.8	11.4/37.1m		11.7			9.2/35.8m	11.7			36.0
	38.0		11.1	11.1		11.0	10.7/38.9m			11.0			38.0
	40.0		10.8/38.9m	10.4		10.3	10.3			10.2	10.0/40.6m		40.0
	42.0			9.7		9.7/41.8m	9.6			9.6	9.5		42.0
	44.0			9.1			9.0			8.9	8.9		44.0
	46.0			8.6			8.5			8.8/44.7m	8.4		46.0
	48.0			8.2/47.5m	8.0/48.8m		8.0				7.9		48.0
50.0				7.8		7.6	7.5/51.0m			7.5		50.0	
52.0				7.4		7.5/50.4m	7.3			7.1	7.0/53.1m	52.0	
54.0				7.0			6.9			6.9/53.4m	6.8	54.0	
56.0				6.7/55.5m			6.5				6.4	56.0	
58.0							6.2				6.1	58.0	
60.0							6.1/58.5m				5.8	60.0	
62.0											5.6/61.4m	62.0	

※表中の太線で囲まれた部分は、ブーム等の強度によって定められた値です。

(単位:t)

タワー長さm	51.9								タワー長さm
ジブ長さm	36.6				39.6				ジブ長さm
タワー角度	90°	80°	70°	60°	90°	80°	70°	60°	タワー角度
12.0	23.9/13.3m								12.0
14.0	23.6				22.0/14.1m				14.0
16.0	22.9				21.4				16.0
18.0	22.2				20.8				18.0
20.0	21.4				20.2				20.0
22.0	20.7				19.6				22.0
24.0	19.9				19.0				24.0
26.0	18.8				18.3				26.0
28.0	16.8	16.6/28.2m			16.8	15.4/29.5m			28.0
30.0	15.2	15.0			15.2	14.9			30.0
32.0	14.0	13.8			14.0	13.7			32.0
34.0	12.8	12.6			12.8	12.5			34.0
36.0	11.6	11.6			11.8	11.5			36.0
38.0	9.3	10.9			10.8	10.8			38.0
40.0	8.7/38.7m	10.1			9.3	10.0			40.0
42.0		9.5	9.3/42.4m		7.7/41.7m	9.4			42.0
44.0		8.9	8.8			8.8	8.7/44.1m		44.0
46.0		8.4	8.3			8.2	8.1		46.0
48.0		7.9/47.7m	7.8			7.6	7.6		48.0
50.0			7.4			7.2	7.2		50.0
52.0			7.0			7.1/50.6m	6.8		52.0
54.0			6.6	6.4/55.3m			6.4		54.0
56.0			6.3	6.3			6.1	5.9/57.4m	56.0
58.0			6.3/56.3m	6.0			5.8	5.8	58.0
60.0				5.7			5.6/59.3m	5.5	60.0
62.0				5.4				5.2	62.0
64.0				5.2				5.0	64.0
66.0				5.1/64.4m				4.8	66.0
68.0								4.6/67.3m	68.0

※表中の太線で囲まれた部分は、ブーム等の強度によって定められた値です。

(単位:t)

タワー長さm	51.9								タワー長さm
ジブ長さm	42.7				45.7				ジブ長さm
タワー角度	90°	80°	70°	60°	90°	80°	70°	60°	タワー角度
14.0	20.0/14.9m				17.4/15.7m				14.0
16.0	19.7				17.4				16.0
18.0	19.2				16.9				18.0
20.0	18.6				16.4				20.0
22.0	18.1				16.0				22.0
24.0	17.5				15.5				24.0
26.0	17.0				15.0				26.0
28.0	16.5				14.6				28.0
30.0	15.2	14.4/30.8m			14.1				30.0
32.0	14.0	13.6			13.6	13.4/32.1m			32.0
34.0	12.8	12.4			12.6	12.3			34.0
36.0	11.8	11.4			11.6	11.3			36.0
38.0	10.8	10.6			10.6	10.5			38.0
40.0	9.8	9.8			9.7	9.7			40.0
42.0	8.9	9.2			8.9	9.0			42.0
44.0	7.2	8.6	7.9/45.9m		8.1	8.4			44.0
46.0	6.8/44.6m	8.0	7.9		7.1	7.8	7.4/47.6m		46.0
48.0		7.4	7.4		6.1/47.5m	7.2	7.3		48.0
50.0		7.0	7.0			6.8	6.8		50.0
52.0		6.6	6.6			6.4	6.4		52.0
54.0		6.2/53.6m	6.2			6.0	6.0		54.0
56.0			5.9			5.7	5.7		56.0
58.0			5.6	5.3/59.6m		5.6/56.5m	5.4		58.0
60.0			5.4	5.3			5.2	4.8/61.7m	60.0
62.0			5.2	5.0			5.0	4.8	62.0
64.0			5.2/62.2m	4.8			4.8	4.6	64.0
66.0				4.6			4.6/65.2m	4.4	66.0
68.0				4.4				4.2	68.0
70.0				4.2				4.0	70.0
72.0				4.2/70.2m				3.8	72.0
74.0								3.7/73.2m	74.0

※表中の太線で囲まれた部分は、ブーム等の強度によって定められた値です。



# ▶タワー長さ 54.9m

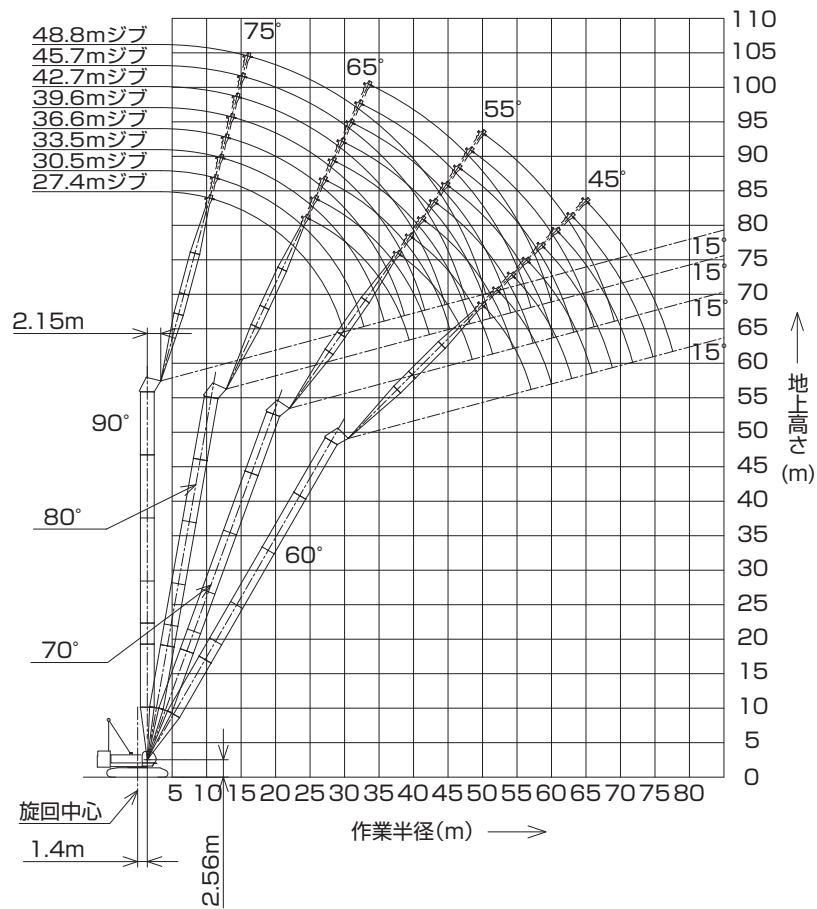

(単位:t)

タワー長さm	54.9												タワー長さm
ジブ長さm	27.4				30.5				33.5				ジブ長さm
タワー角度	90°	80°	70°	60°	90°	80°	70°	60°	90°	80°	70°	60°	タワー角度
作業半径 (m)	10.0	25.0/10.9m			25.0/11.7m								10.0
	12.0	25.0			25.0				25.0/12.5m				12.0
	14.0	25.0			25.0				25.0				14.0
	16.0	25.0			25.0				24.2				16.0
	18.0	25.0			24.2				23.4				18.0
	20.0	24.2			23.5				22.6				20.0
	22.0	23.2			22.7				21.7				22.0
	24.0	20.9	20.0/24.9m		21.0				21.0				24.0
	26.0	18.5	18.6		18.6	18.6/26.2m			18.8	17.2/27.5m			26.0
	28.0	16.3	16.8		16.7	16.7			16.7	16.7			28.0
	30.0	11.3/29.9m	15.2		15.1	15.1			15.3	15.1			30.0
	32.0		14.0		12.0	13.9			14.0	13.9			32.0
	34.0		12.8		10.6/32.8m	12.7			12.2	12.7			34.0
	36.0		11.8			11.7			9.3/35.8m	11.7			36.0
	38.0		11.1	11.0/38.2m		11.0	10.3/39.9m			11.0			38.0
	40.0		10.6/39.4m	10.4		10.3	10.3			10.2	9.6/41.7m		40.0
	42.0			9.7		9.5	9.6			9.6	9.5		42.0
	44.0			9.1		9.5/42.3m	9.0			8.9	8.9		44.0
	46.0			8.6			8.5			8.6/45.3m	8.4		46.0
	48.0			8.2			8.0				7.9		48.0
50.0			8.1/48.5m	7.7/50.3m		7.6				7.5		50.0	
52.0				7.4		7.3/51.5m	7.2/52.5m			7.1		52.0	
54.0				7.0			6.9			6.8	6.7/54.6m	54.0	
56.0				6.6			6.5			6.7/54.4m	6.4	56.0	
58.0				6.4/57.0m			6.1				6.0	58.0	
60.0							5.8/60.0m				5.7	60.0	
62.0											5.4	62.0	
64.0											5.3/62.9m	64.0	

※表中の太線で囲まれた部分は、ブーム等の強度によって定められた値です。

(単位:t)

タワー長さm		54.9												タワー長さm
ジブ長さm		36.6				39.6				42.7				ジブ長さm
タワー角度		90°	80°	70°	60°	90°	80°	70°	60°	90°	80°	70°	60°	タワー角度
作業半径(m)	12.0	23.9/13.3m												12.0
	14.0	23.6				22.0/14.1m				20.0/14.9m				14.0
	16.0	22.9				21.4				19.7				16.0
	18.0	22.2				20.8				19.2				18.0
	20.0	21.4				20.2				18.6				20.0
	22.0	20.7				19.6				18.1				22.0
	24.0	19.9				19.0				17.5				24.0
	26.0	18.8				18.3				17.0				26.0
	28.0	16.8	16.2/28.8m			16.8				16.5				28.0
	30.0	15.2	15.0			15.2	14.9/30.1m			15.2	14.1/31.4m			30.0
	32.0	14.0	13.8			14.0	13.7			14.0	13.6			32.0
	34.0	12.8	12.6			12.8	12.5			12.8	12.4			34.0
	36.0	11.6	11.6			11.8	11.5			11.8	11.4			36.0
	38.0	9.3	10.9			10.8	10.8			10.8	10.6			38.0
	40.0	8.7/38.7m	10.1			9.5	10.0			9.8	9.8			40.0
	42.0		9.5	9.0/43.4m		7.9/41.7m	9.4			8.8	9.2			42.0
	44.0		8.9	8.8			8.8	8.3/45.2m		7.3	8.6			44.0
	46.0		8.4	8.3			8.2	8.1		6.9/44.6m	8.0	7.7/46.9m		46.0
	48.0		7.8	7.8			7.6	7.6			7.4	7.4		48.0
	50.0		7.8/48.2m	7.4			7.2	7.2			7.0	7.0		50.0
	52.0			7.0			6.9/51.2m	6.8			6.6	6.6		52.0
	54.0			6.6				6.4			6.2	6.2		54.0
	56.0			6.3	6.1/56.8m			6.1			6.2/54.1m	5.9		56.0
	58.0			6.0/57.4m	5.9			5.8	5.7/58.9m			5.6		58.0
60.0				5.6			5.6	5.5			5.4	5.1/61.1m	60.0	
62.0				5.3			5.6/60.3m	5.3			5.2	5.0	62.0	
64.0				5.1				5.0			5.0/63.3m	4.8	64.0	
66.0				4.9/65.9m				4.8				4.6	66.0	
68.0								4.6				4.4	68.0	
70.0								4.5/68.8m				4.2	70.0	
72.0												4.0/71.8m	72.0	

※表中の太線で囲まれた部分は、ブーム等の強度によって定められた値です。

(単位:t)

タワー長さm		54.9												タワー長さm
ジブ長さm		45.7				48.8				48.8				ジブ長さm
タワー角度		90°	80°	70°	60°	90°	80°	70°	60°	90°	80°	70°	60°	タワー角度
作業半径(m)	14.0	17.4/15.7m												14.0
	16.0	17.4					15.4/16.5m							16.0
	18.0	16.9					15.0							18.0
	20.0	16.4					14.6							20.0
	22.0	16.0					14.2							22.0
	24.0	15.5					13.7							24.0
	26.0	15.0					13.3							26.0
	28.0	14.6					12.9							28.0
	30.0	14.1					12.5							30.0
	32.0	13.6	13.4/32.6m				12.0	12.1/33.9m						32.0
	34.0	12.6	12.3				11.6	12.1						34.0
	36.0	11.6	11.3				10.9	11.1						36.0
	38.0	10.6	10.5				10.1	10.2						38.0
	40.0	9.7	9.7				9.4	9.4						40.0
	42.0	8.8	9.0				8.6	8.7						42.0
	44.0	8.1	8.4				7.9	8.1						44.0
	46.0	7.1	7.8				7.3	7.6						46.0
	48.0	6.1/47.5m	7.2	7.1/48.7m			6.6	7.0						48.0
	50.0		6.8	6.8			5.6	6.6	6.5/50.4m					50.0
	52.0		6.4	6.4			5.3/50.5m	6.2	6.2					52.0
	54.0		6.0	6.0				5.8	5.8					54.0
	56.0		5.7	5.7				5.5	5.5					56.0
	58.0		5.5/57.0m	5.4				5.2	5.2					58.0
	60.0			5.2				5.0/60.0m	5.0					60.0
62.0			5.0	4.7/63.3m				4.8					62.0	
64.0			4.8	4.6				4.6			4.3/65.4m		64.0	
66.0			4.6	4.4				4.4			4.2		66.0	
68.0			4.6/66.2m	4.2				4.2			4.0		68.0	
70.0				4.0				4.1/69.1m			3.8		70.0	
72.0				3.8							3.6		72.0	
74.0				3.6							3.4		74.0	
76.0				3.5/74.7m							3.2		76.0	
78.0											3.0/77.7m		78.0	

※表中の太線で囲まれた部分は、ブーム等の強度によって定められた値です。

# ▶タワー長さ 58.0m

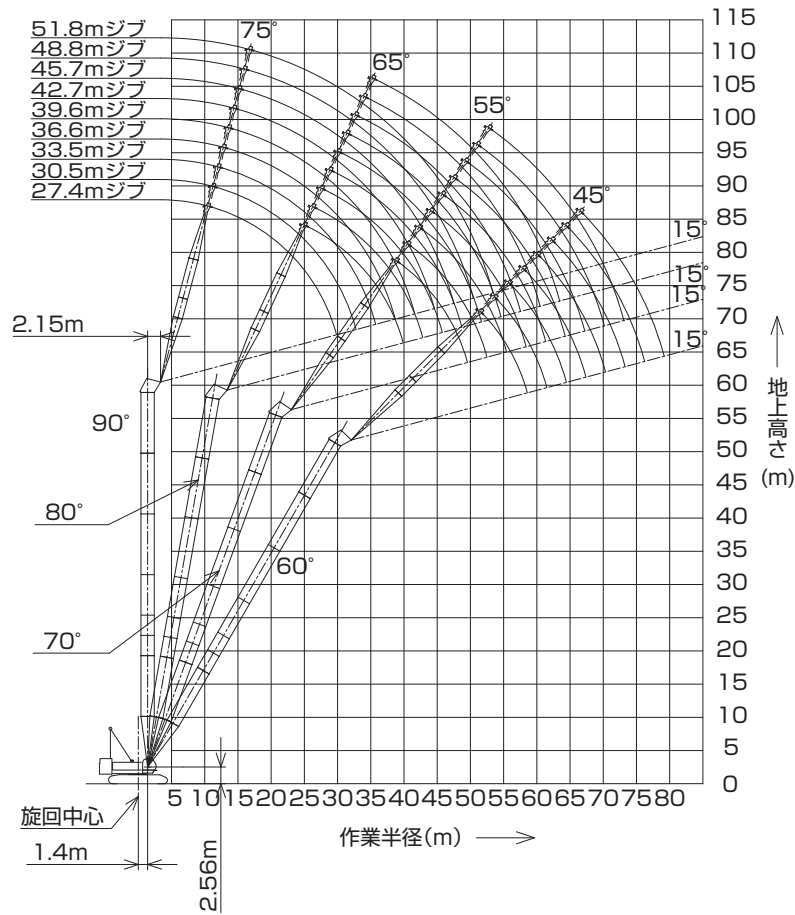

(単位:t)

タワー長さm	58.0												タワー長さm
ジブ長さm	27.4				30.5				33.5				ジブ長さm
タワー角度	90°	80°	70°	60°	90°	80°	70°	60°	90°	80°	70°	60°	タワー角度
作業半径 (m)	10.0	25.0/10.9m			25.0/11.7m				25.0/12.5m				10.0
	12.0	25.0			25.0				25.0				12.0
	14.0	25.0			25.0				24.2				14.0
	16.0	25.0			25.0				23.4				16.0
	18.0	24.9			24.2				22.6				18.0
	20.0	24.0			23.5				21.7				20.0
	22.0	23.0			22.7				21.0				22.0
	24.0	20.7	19.4/25.4m		21.0				18.8				24.0
	26.0	18.3	18.6		18.6	18.1/26.7m			16.7	16.7/28.0m			26.0
	28.0	16.3	16.8		16.7	16.7			15.3	15.1			28.0
	30.0	11.3/29.9m	15.2		15.1	15.1			14.0	13.9			30.0
	32.0		14.0		12.0	13.9			12.2	12.7			32.0
	34.0		12.8		10.6/32.8m	12.7			9.3/35.8m	11.7			34.0
	36.0		11.8			11.7			11.0				36.0
	38.0		11.1	10.6/39.7m		11.0			10.2				38.0
	40.0		10.4/39.9m	10.4		10.3	10.0/41.0m		9.6	9.2/42.7m			40.0
	42.0			9.7		9.5	9.6		8.9	8.9			42.0
	44.0			9.1		9.3/42.9m	9.0		8.5	8.4			44.0
	46.0			8.6			8.5		7.9	7.9			46.0
	48.0			8.2			8.0		7.5	7.1			48.0
50.0			7.9/49.6m	7.4/51.8m		7.6		6.8	6.8			50.0	
52.0				7.0		7.3		6.5	6.5/55.5m	6.4/56.2m		52.0	
54.0						7.2/52.5m	6.9/54.0m					54.0	
56.0				6.6			6.5					56.0	
58.0				6.2			6.1					58.0	
60.0				6.1/58.6m			5.8					60.0	
62.0							5.6/61.5m					62.0	
64.0												64.0	
66.0											5.0/64.5m	66.0	

※表中の太線で囲まれた部分は、ブーム等の強度によって定められた値です。

(単位:t)

タワー長さm		58.0												タワー長さm
ジブ長さm		36.6				39.6				42.7				ジブ長さm
タワー角度		90°	80°	70°	60°	90°	80°	70°	60°	90°	80°	70°	60°	タワー角度
作業半径(m)	12.0	23.9/13.3m												12.0
	14.0	23.6				22.0/14.1m				20.0/14.9m				14.0
	16.0	22.9				21.4				19.7				16.0
	18.0	22.2				20.8				19.2				18.0
	20.0	21.4				20.2				18.6				20.0
	22.0	20.7				19.6				18.1				22.0
	24.0	19.9				19.0				17.5				24.0
	26.0	18.8				18.3				17.0				26.0
	28.0	16.8	15.7/29.3m			16.8				16.5				28.0
	30.0	15.2	15.0			15.2	14.8/30.6m			15.2	13.7/31.9m			30.0
	32.0	14.0	13.8			14.0	13.7			14.0	13.6			32.0
	34.0	12.8	12.6			12.8	12.5			12.8	12.4			34.0
	36.0	11.6	11.6			11.8	11.5			11.8	11.4			36.0
	38.0	9.5	10.9			10.7	10.8			10.8	10.6			38.0
	40.0	8.9/38.7m	10.1			9.5	10.0			9.8	9.8			40.0
	42.0		9.5			7.9/41.7m	9.4			8.8	9.2			42.0
	44.0		8.9	8.7/44.5m			8.8			7.4	8.6			44.0
	46.0		8.4	8.3			8.2	8.1/46.2m		7.0/44.6m	8.0			46.0
	48.0		7.8	7.8			7.6	7.6		7.4	7.4/48.0m			48.0
	50.0		7.7/48.7m	7.4			7.2	7.2		7.0	7.0			50.0
	52.0			7.0			6.8/51.7m	6.8		6.6	6.6			52.0
	54.0			6.6				6.4		6.2	6.2			54.0
	56.0			6.3				6.1		6.1/54.6m	5.9			56.0
	58.0			6.0	5.8/58.3m			5.8			5.6			58.0
	60.0			5.9/58.4m	5.6			5.6	5.3/60.5m		5.4			60.0
	62.0				5.3			5.4/61.3m	5.1		5.2	4.8/62.6m		62.0
	64.0				5.0				4.8		4.9	4.6		64.0
	66.0				4.8				4.6		4.8/64.3m	4.4		66.0
68.0				4.6/67.4m				4.4			4.2		68.0	
70.0								4.2			4.0		70.0	
72.0								4.2/70.3m			3.8		72.0	
74.0											3.6/73.3m		74.0	

※表中の太線で囲まれた部分は、ブーム等の強度によって定められた値です。

(単位:t)

タワー長さm		58.0												タワー長さm
ジブ長さm		45.7				48.8				51.8				ジブ長さm
タワー角度		90°	80°	70°	60°	90°	80°	70°	60°	90°	80°	70°	タワー角度	
作業半径(m)	14.0	17.4/15.7m											14.0	
	16.0	17.4				15.4/16.5m				13.9/17.2m			16.0	
	18.0	16.9				15.0				13.7			18.0	
	20.0	16.4				14.6				13.3			20.0	
	22.0	16.0				14.2				12.8			22.0	
	24.0	15.5				13.7				12.4			24.0	
	26.0	15.0				13.3				12.0			26.0	
	28.0	14.6				12.9				11.6			28.0	
	30.0	14.1				12.5				11.2			30.0	
	32.0	13.6	12.7/33.2m			12.0				10.8			32.0	
	34.0	12.6	12.3			11.6	11.8/34.5m			10.4	10.6/35.7m		34.0	
	36.0	11.5	11.3			10.9	11.1			9.8	10.4		36.0	
	38.0	10.6	10.5			10.1	10.2			9.1	9.7		38.0	
	40.0	9.6	9.7			9.4	9.4			8.5	9.0		40.0	
	42.0	8.8	9.0			8.6	8.7			7.9	8.4		42.0	
	44.0	8.1	8.4			7.9	8.1			7.4	7.8		44.0	
	46.0	7.1	7.8			7.3	7.6			6.9	7.3		46.0	
	48.0	6.1/47.5m	7.2	6.9/49.7m		6.6	7.0			6.3	6.8		48.0	
	50.0		6.8	6.8		5.6	6.6	6.3/51.5m		5.9	6.4		50.0	
	52.0		6.4	6.4		5.3/50.5m	6.2	6.2		5.4	6.0	5.7/53.2m	52.0	
	54.0		6.0	6.0			5.8	5.8		4.9/53.4m	5.6	5.6	54.0	
	56.0		5.7	5.7			5.5	5.5			5.3	5.3	56.0	
	58.0		5.4/57.6m	5.4			5.2	5.2			5.0	5.0	58.0	
	60.0			5.2			5.0	5.0			4.8	4.8	60.0	
	62.0			5.0			4.9/60.5m	4.8			4.6	4.6	62.0	
	64.0			4.8	4.3/64.8m			4.6			4.3/63.5m	4.4	64.0	
	66.0			4.6	4.2			4.4	3.9/66.9m			4.2	66.0	
	68.0			4.4/67.2m	4.0			4.2	3.8			4.0	68.0	
70.0				3.8			4.0	3.6			3.8	70.0		
72.0				3.6			4.0/70.2m	3.4			3.6	72.0		
74.0				3.4				3.2			3.5/73.1m	74.0		
76.0				3.2				3.0				76.0		
78.0				3.2/76.2m				2.8				78.0		
80.0								2.7/79.2m				80.0		

※表中の太線で囲まれた部分は、ブーム等の強度によって定められた値です。

# ▶タワー長さ 61.0m

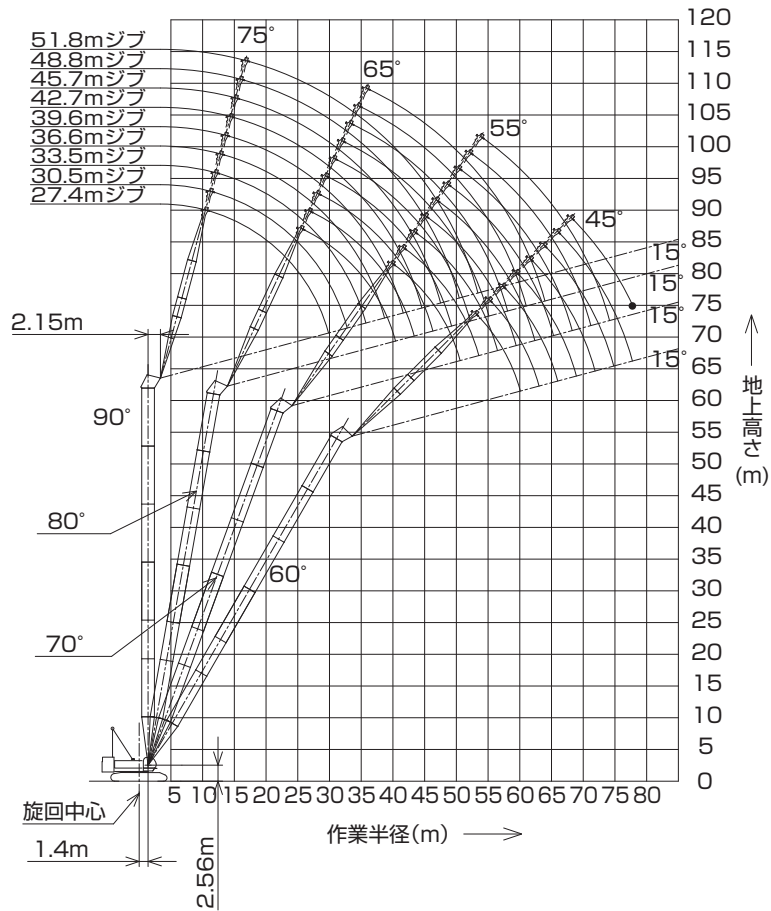

(単位:t)

タワー長さm	61.0												タワー長さm
ジブ長さm	27.4				30.5				33.5				ジブ長さm
タワー角度	90°	80°	70°	60°	90°	80°	70°	60°	90°	80°	70°	60°	タワー角度
作業半径(m)	10.0	25.0/10.9m			25.0/11.7m				25.0/12.5m				10.0
	12.0	25.0			25.0				25.0/12.5m				12.0
	14.0	25.0			25.0				25.0				14.0
	16.0	24.6			24.6				24.0				16.0
	18.0	23.7			23.7				23.0				18.0
	20.0	22.9			22.7				22.0				20.0
	22.0	21.5			21.5				21.0				22.0
	24.0	20.0			20.0				20.0				24.0
	26.0	18.3	18.6/26.0m		18.6	17.4/27.3m			18.8				26.0
	28.0	16.3	16.8		16.7	16.7			16.7	16.4/28.5m			28.0
	30.0	11.3/29.9m	15.2		15.1	15.1			15.3	15.1			30.0
	32.0		14.0		12.0	13.9			14.0	13.9			32.0
	34.0		12.8		10.6/32.8m	12.7			12.3	12.7			34.0
	36.0		11.8			11.7			9.4/35.8m	11.7			36.0
	38.0		11.1			11.0				11.0			38.0
	40.0		10.4	10.3/40.3m		10.3				10.2			40.0
	42.0		10.2/40.4m	9.7		9.5	9.6/42.0m			9.6	8.8/43.8m		42.0
	44.0			9.1		9.2/43.4m	9.0			8.9	8.8		44.0
	46.0			8.6			8.5			8.4	8.4		46.0
	48.0			8.2			8.0			8.4/46.3m	7.9		48.0
50.0			7.8			7.6				7.5		50.0	
52.0			7.7/50.6m	6.8/53.4m		7.3				7.1		52.0	
54.0				6.7		6.9/53.6m	6.4/55.5m			6.7		54.0	
56.0				6.4			6.3			6.4	5.7/57.7m	56.0	
58.0				6.1			6.0			6.3/56.5m	5.7	58.0	
60.0				5.8			5.7				5.5	60.0	
62.0				5.8/60.1m			5.4				5.2	62.0	
64.0							5.2/63.0m				5.0	64.0	
66.0											4.8	66.0	
68.0											4.8/66.0m	68.0	

※表中の太線で囲まれた部分は、ブーム等の強度によって定められた値です。

(単位:t)

タワー長さm		61.0												タワー長さm
ジブ長さm		36.6				39.6				42.7				ジブ長さm
タワー角度		90°	80°	70°	60°	90°	80°	70°	60°	90°	80°	70°	60°	タワー角度
作業半径(m)	12.0	23.9/13.3m												12.0
	14.0	23.6				22.0/14.1m				20.0/14.9m				14.0
	16.0	22.9				21.4				19.7				16.0
	18.0	22.2				20.8				19.2				18.0
	20.0	21.4				20.2				18.6				20.0
	22.0	20.7				19.6				18.1				22.0
	24.0	19.9				19.0				17.5				24.0
	26.0	18.8				18.3				17.0				26.0
	28.0	16.8	15.2/29.8m			16.8				16.5				28.0
	30.0	15.2	15.0			15.2	14.3/31.1m			15.2				30.0
	32.0	14.0	13.8			14.0	13.7			14.0	13.5/32.4m			32.0
	34.0	12.8	12.6			12.8	12.5			12.8	12.4			34.0
	36.0	11.5	11.6			11.8	11.5			11.8	11.4			36.0
	38.0	9.5	10.9			10.7	10.8			10.8	10.6			38.0
	40.0	8.9/38.7m	10.1			9.5	10.0			9.8	9.8			40.0
	42.0		9.5			7.9/41.7m	9.4			8.9	9.2			42.0
	44.0		8.9	8.4/45.5m			8.8			7.4	8.6			44.0
	46.0		8.4	8.3			8.2	7.8/47.3m		6.9/44.6m	8.0			46.0
	48.0		7.8	7.8			7.6	7.6			7.4	7.2/49.0m		48.0
	50.0		7.5/49.3m	7.4			7.2	7.2			7.0	7.0		50.0
	52.0			7.0			6.8	6.8			6.6	6.6		52.0
	54.0			6.6			6.8/52.2m	6.4			6.2	6.2		54.0
	56.0			6.3				6.1			5.9/55.2m	5.9		56.0
	58.0			6.0	5.3/59.8m			5.8				5.6		58.0
	60.0			5.8/59.4m	5.3			5.6				5.4		60.0
	62.0				5.1			5.4	4.9/62.0m			5.2		62.0
	64.0				4.9			5.3/62.4m	4.7			5.0	4.0/64.1m	64.0
	66.0				4.7				4.5			4.9/65.3m	4.0	66.0
68.0				4.4				4.2				3.8	68.0	
70.0				4.3/68.9m				3.9				3.6	70.0	
72.0								3.6				3.4	72.0	
74.0								3.6/71.9m				3.2	74.0	
76.0												3.1/74.8m	76.0	

※表中の太線で囲まれた部分は、ブーム等の強度によって定められた値です。

(単位:t)

タワー長さm		61.0												タワー長さm
ジブ長さm		45.7				48.8				51.8				ジブ長さm
タワー角度		90°	80°	70°	60°	90°	80°	70°	60°	90°	80°	70°	タワー角度	
作業半径(m)	14.0	17.4/15.7m											14.0	
	16.0	17.4				15.4/16.5m				13.9/17.2m			16.0	
	18.0	16.9				15.0				13.7			18.0	
	20.0	16.4				14.6				13.3			20.0	
	22.0	16.0				14.2				12.8			22.0	
	24.0	15.5				13.7				12.4			24.0	
	26.0	15.0				13.3				12.0			26.0	
	28.0	14.6				12.9				11.6			28.0	
	30.0	14.1				12.5				11.2			30.0	
	32.0	13.6	12.6/33.7m			12.0				10.8			32.0	
	34.0	12.6	12.3			11.6	11.4/35.0m			10.4			34.0	
	36.0	11.5	11.3			10.8	11.0			9.8	9.7/36.3m		36.0	
	38.0	10.4	10.5			9.9	10.1			9.1	9.3		38.0	
	40.0	9.5	9.7			9.3	9.3			8.5	8.7		40.0	
	42.0	8.7	9.0			8.5	8.6			7.9	8.2		42.0	
	44.0	8.1	8.4			7.8	8.0			7.4	7.6		44.0	
	46.0	7.2	7.8			7.3	7.5			6.9	7.1		46.0	
	48.0	6.2/47.5m	7.2			6.6	6.9			6.3	6.6		48.0	
	50.0		6.8	6.7/50.8m		5.6	6.5			5.8	6.2		50.0	
	52.0		6.4	6.4		5.3/50.5m	6.1	6.0/52.5m		5.3	5.8		52.0	
	54.0		6.0	6.0			5.7	5.7		4.9/53.4m	5.4	5.3/54.2m	54.0	
	56.0		5.7	5.7			5.4	5.4			5.1	5.1	56.0	
	58.0		5.4	5.4			5.1	5.1			4.8	4.8	58.0	
	60.0		5.4/58.1m	5.2			4.9	4.9			4.6	4.6	60.0	
	62.0			5.0			4.7/61.0m	4.7			4.4	4.4	62.0	
	64.0			4.8				4.5			4.1/64.0m	4.2	64.0	
	66.0			4.6	3.7/66.3m			4.3				4.0	66.0	
	68.0			4.3	3.5			4.1				3.8	68.0	
70.0			4.3/68.3m	3.3			3.9	3.1/70.0m			3.6	70.0		
72.0				3.1			3.8/71.2m	2.9			3.4	72.0		
74.0				2.9				2.7			3.2	74.0		
76.0				2.7				2.5			3.2/74.2m	76.0		
78.0				2.5/77.8m				2.3/78.0m				78.0		

※表中の太線で囲まれた部分は、ブーム等の強度によって定められた値です。

# ▶タワー長さ 64.1m

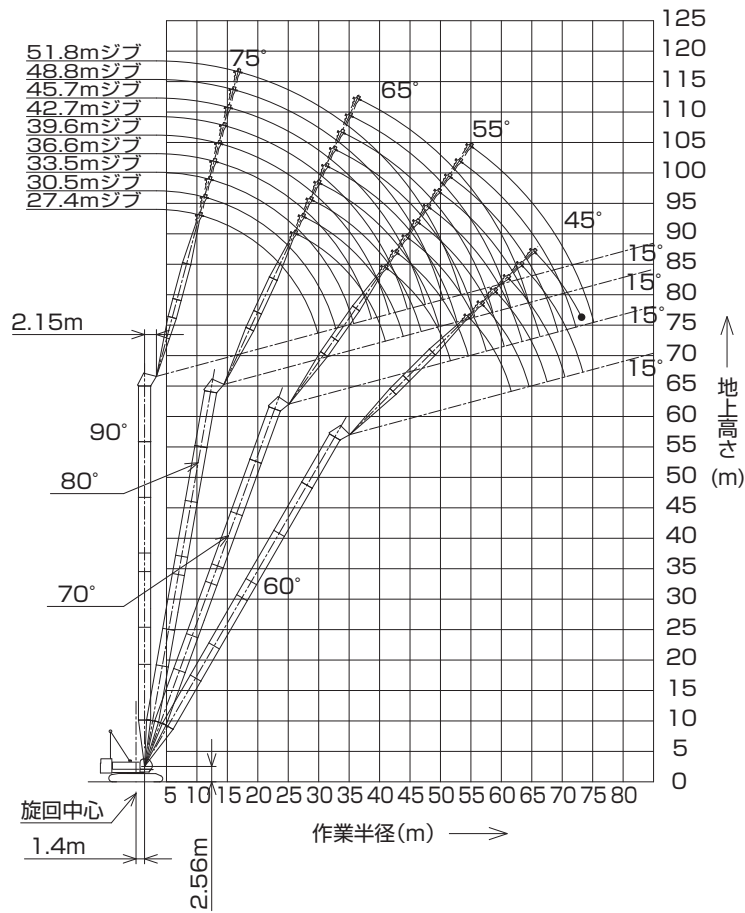

(単位:t)

タワー長さm	64.1												タワー長さm
ジブ長さm	27.4				30.5				33.5				ジブ長さm
タワー角度	90°	80°	70°	60°	90°	80°	70°	60°	90°	80°	70°	60°	タワー角度
作業半径(m)	10.0	25.0/10.9m			25.0/11.7m								10.0
	12.0	25.0			25.0				24.8/12.5m				12.0
	14.0	24.3			24.3				24.3				14.0
	16.0	23.6			23.6				23.6				16.0
	18.0	22.9			22.9				22.9				18.0
	20.0	22.2			22.2				22.0				20.0
	22.0	21.5			21.5				21.0				22.0
	24.0	20.0			20.0				20.0				24.0
	26.0	18.3	18.3/26.5m		18.6	15.9/27.8m			18.8				26.0
	28.0	16.3	16.8		16.7	16.7			16.7	15.9/29.1m			28.0
	30.0	11.3/29.9m	15.2		15.1	15.1			15.3	15.1			30.0
	32.0		14.0		12.0	13.9			14.0	13.9			32.0
	34.0		12.8		10.6/32.8m	12.7			12.3	12.7			34.0
	36.0		11.8			11.7			9.4/35.8m	11.7			36.0
	38.0		11.1			11.0				11.0			38.0
	40.0		10.4	9.9/41.3m		10.3				10.2			40.0
	42.0		10.0/41.0m	9.7		9.5	9.3/43.1m			9.6			42.0
	44.0			9.1			9.0/43.9m	9.0		8.9	8.7/44.8m		44.0
	46.0			8.6			8.5			8.4	8.4		46.0
	48.0			8.2			8.0			8.2/46.9m	7.9		48.0
50.0			7.8			7.6				7.5		50.0	
52.0			7.4/51.7m			7.3				7.1		52.0	
54.0				6.0/54.9m		6.9				6.7		54.0	
56.0				5.9		6.7/54.6m	5.4/57.1m			6.4		56.0	
58.0				5.7			5.3			6.2/57.5m	4.9/59.2m	58.0	
60.0				5.5			5.1				4.8	60.0	
62.0				5.3/61.6m			4.9				4.6	62.0	
64.0							4.7				4.4	64.0	
66.0							4.6/64.6m				4.2	66.0	
68.0											4.0/67.5m	68.0	

※表中の太線で囲まれた部分は、ブーム等の強度によって定められた値です。

(単位:t)

タワー長さm		64.1												タワー長さm
ジブ長さm		36.6				39.6				42.7				ジブ長さm
タワー角度		90°	80°	70°	60°	90°	80°	70°	60°	90°	80°	70°	60°	タワー角度
作業半径(m)	12.0	23.9/13.3m												12.0
	14.0	23.6				22.0/14.1m				20.0/14.9m				14.0
	16.0	22.9				21.4				19.7				16.0
	18.0	22.2				20.8				19.2				18.0
	20.0	21.4				20.2				18.6				20.0
	22.0	20.7				19.6				18.1				22.0
	24.0	19.9				19.0				17.5				24.0
	26.0	18.8				18.3				17.0				26.0
	28.0	16.8				16.8				16.5				28.0
	30.0	15.2	14.9/30.4m			15.2	13.9/31.7m			15.2				30.0
	32.0	14.0	13.8			14.0	13.7			14.0	13.3/32.9m			32.0
	34.0	12.8	12.6			12.8	12.5			12.8	12.4			34.0
	36.0	11.5	11.6			11.8	11.5			11.8	11.4			36.0
	38.0	9.5	10.9			10.7	10.8			10.8	10.6			38.0
	40.0	8.9/38.7m	10.1			9.5	10.0			9.7	9.8			40.0
	42.0		9.5			7.9/41.7m	9.4			8.8	9.2			42.0
	44.0		8.9				8.8			8.8	8.6			44.0
	46.0		8.4	8.1/46.5m			8.2			6.9/44.6m	8.0			46.0
	48.0		7.8	7.8			7.6	7.6/48.3m			7.4			48.0
	50.0		7.4/49.8m	7.4			7.2	7.2			7.0	7.0/50.0m		50.0
	52.0			7.0			6.7	6.8			6.6	6.6		52.0
	54.0			6.6			6.6/52.7m	6.4			6.1	6.2		54.0
	56.0			6.3				6.1			5.8/55.7m	5.9		56.0
	58.0			6.0				5.8				5.6		58.0
	60.0			5.7	4.5/61.4m			5.6				5.4		60.0
	62.0			5.6/60.5m	4.4			5.4	4.0/63.5m			5.2		62.0
	64.0				4.2			5.3/63.4m	4.0			5.0		64.0
	66.0				4.0				3.8			4.8	3.4/66.0m	66.0
68.0				3.8				3.6			4.7/66.4m	3.4	68.0	
70.0				3.6				3.4				3.2	70.0	
72.0				3.5/70.5m				3.2				3.0	72.0	
74.0								3.0/73.4m				2.8/74.0m	74.0	

※表中の太線で囲まれた部分は、ブーム等の強度によって定められた値です。

(単位:t)

タワー長さm		64.1									タワー長さm
ジブ長さm		45.7			48.8			51.8			ジブ長さm
タワー角度		90°	80°	70°	90°	80°	70°	90°	80°	70°	タワー角度
作業半径(m)	14.0	17.4/15.7m									14.0
	16.0	17.4			15.4/16.5m			13.9/17.2m			16.0
	18.0	16.9			15.0			13.7			18.0
	20.0	16.4			14.6			13.3			20.0
	22.0	16.0			14.2			12.8			22.0
	24.0	15.5			13.7			12.4			24.0
	26.0	15.0			13.3			11.9			26.0
	28.0	14.6			12.9			11.5			28.0
	30.0	14.1			12.5			11.1			30.0
	32.0	13.6			12.0			10.8			32.0
	34.0	12.6	12.3/34.2m		11.6	11.4/35.5m		10.4			34.0
	36.0	11.5	11.3		10.8	11.0		9.8	9.2/36.8m		36.0
	38.0	10.4	10.5		9.9	10.1		9.1	9.0		38.0
	40.0	9.5	9.7		9.3	9.3		8.5	8.4		40.0
	42.0	8.7	9.0		8.5	8.6		7.9	7.9		42.0
	44.0	7.9	8.4		7.8	8.0		7.4	7.3		44.0
	46.0	7.1	7.8		7.1	7.5		6.8	6.8		46.0
	48.0	6.2/47.5m	7.2		6.4	6.9		6.2	6.3		48.0
	50.0		6.8	6.4/51.8m	5.6	6.5		5.6	5.9		50.0
	52.0		6.4	6.4	5.3/50.5m	6.1	5.8/53.5m	5.0	5.5		52.0
	54.0		6.0	6.0		5.7	5.7	4.5/53.4m	5.1	4.9/55.3m	54.0
	56.0		5.7	5.7		5.4	5.4		4.8	4.8	56.0
	58.0		5.4	5.4		5.1	5.1		4.5	4.5	58.0
	60.0		5.3/58.6m	5.2		4.9	4.9		4.3	4.3	60.0
	62.0			5.0		4.7/61.6m	4.7		4.1	4.1	62.0
	64.0			4.8			4.5		3.8	3.9	64.0
	66.0			4.6			4.3		3.7/64.5m	3.7	66.0
	68.0			4.4			4.1			3.5	68.0
70.0			4.3/69.3m			3.9			3.3	70.0	
72.0						3.8			3.1	72.0	
74.0						3.7/72.3m			3.0	74.0	
76.0									2.9/75.2m	76.0	

※表中の太線で囲まれた部分は、ブーム等の強度によって定められた値です。



▶ タワー長さ36.6m (75.1tカウンタウエイト/カーボディウエイトなし)(オプション)

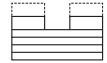

(単位:t)

タワー長さm	36.6								タワー長さm
ジブ長さm	27.4				30.5				ジブ長さm
タワー角度	90°	80°	70°	60°	90°	80°	70°	60°	タワー角度
作業半径(m)	10.0	25.0/10.9m			24.4/11.7m				10.0
	12.0	25.0			24.2				12.0
	14.0	25.0			23.8				14.0
	16.0	24.6			23.4				16.0
	18.0	24.2			23.0				18.0
	20.0	23.8	19.0/21.7m		22.6				20.0
	22.0	23.1	18.3		22.2	18.2/23.0m			22.0
	24.0	19.9	16.3		20.3	16.2			24.0
	26.0	17.1	14.8		17.7	14.7			26.0
	28.0	14.1	13.4		15.5	13.3			28.0
	30.0	10.2/29.9m	12.3	11.6/31.9m	13.4	12.2			30.0
	32.0		11.4	11.4	10.5	11.3	10.5/33.7m		32.0
	34.0		10.6	10.6	8.9/32.8m	10.5	10.4		34.0
	36.0		9.9	9.9		9.8	9.7		36.0
	38.0		8.2/36.2m	9.3		9.2	9.1		38.0
	40.0			8.8	8.5/41.2m		8.9/39.2m	8.6	40.0
	42.0			8.3	8.2		8.1	7.6/43.3m	42.0
	44.0			8.2/42.3m	7.7		7.6	7.4	44.0
	46.0				7.2		7.5/45.2m	7.0	46.0
	48.0				6.7/47.9m			6.6	48.0
50.0							6.2	50.0	
52.0							6.0/50.8m	52.0	

※表中の太線で囲まれた部分は、ブーム等の強度によって定められた値です。  
ジブ長さ27.4mでの、ボールフックの使用はできません。

▶ タワー長さ39.7m (75.1tカウンタウエイト/カーボディウエイトなし)(オプション)

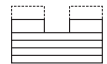

(単位:t)

タワー長さm	39.7								タワー長さm				
ジブ長さm	27.4				30.5				33.5		ジブ長さm		
タワー角度	90°	80°	70°	60°	90°	80°	70°	60°	90°	80°	70°	60°	タワー角度
作業半径(m)	10.0	25.0/10.9m			24.4/11.7m								10.0
	12.0	25.0			24.2				22.7/12.5m				12.0
	14.0	25.0			23.8				22.3				14.0
	16.0	24.6			23.4				21.9				16.0
	18.0	24.2			23.0				21.5				18.0
	20.0	23.8			22.6				21.1				20.0
	22.0	23.1	18.3/22.3m		22.2	16.8/23.6m			20.7				22.0
	24.0	19.9	16.3		20.3	16.2			20.3	15.7/24.8m			24.0
	26.0	17.1	14.8		17.7	14.7			18.0	14.6			26.0
	28.0	14.1	13.4		15.5	13.3			15.9	13.2			28.0
	30.0	10.2/29.9m	12.3		13.4	12.2			14.0	12.1			30.0
	32.0		11.4	11.0/33.0m	10.5	11.3			12.3	11.2			32.0
	34.0		10.6	10.6	8.9/32.8m	10.5	10.4/34.7m		10.3	10.4			34.0
	36.0		9.9	9.9		9.8	9.7		7.8/35.8m	9.7	9.6/36.5m		36.0
	38.0		9.6/36.7m	9.3		9.2	9.1			9.1	8.9		38.0
	40.0			8.8		8.8/39.7m	8.6			8.6	8.4		40.0
	42.0			8.3	7.7/42.7m		8.1			8.1	7.9		42.0
	44.0			7.9/43.3m	7.4		7.6	7.1/44.9m		7.9/42.6m	7.4		44.0
	46.0				7.0		7.2	6.9			7.0	6.6/47.0m	46.0
	48.0				6.6		7.1/46.3m	6.5			6.6	6.4	48.0
50.0				6.3/49.4m			6.1			6.3/49.2m	6.0	50.0	
52.0							5.7				5.6	52.0	
54.0							5.6/52.4m				5.2	54.0	
56.0											4.9/55.3m	56.0	

※表中の太線で囲まれた部分は、ブーム等の強度によって定められた値です。  
ジブ長さ27.4mでの、ボールフックの使用はできません。

▶ タワー長さ42.7m (75.1tカウンタウエイト/カーボディウエイトなし)(オプション) 

(単位:t)

タワー長さm	42.7																タワー長さm
ジブ長さm	27.4				30.5				33.5				36.6				ジブ長さm
タワー角度	90°	80°	70°	60°	90°	80°	70°	60°	90°	80°	70°	60°	90°	80°	70°	60°	タワー角度
10.0	25.0/10.9m				24.4/11.7m												10.0
12.0	25.0				24.2				22.7/12.5m				21.0/13.3m				12.0
14.0	25.0				23.8				22.3				20.8				14.0
16.0	24.6				23.4				21.9				20.4				16.0
18.0	24.2				23.0				21.5				20.0				18.0
20.0	23.8				22.6				21.1				19.6				20.0
22.0	23.1	17.8/22.8m			22.2				20.7				19.2				22.0
24.0	19.9	16.3			20.3	16.2/24.1m			20.3	15.2/25.4m			18.8				24.0
26.0	17.1	14.8			17.7	14.7			18.0	14.6			18.3	14.1/26.7m			26.0
28.0	14.1	13.4			15.5	13.3			15.9	13.2			16.2	13.1			28.0
30.0	10.2/29.9m	12.3			13.4	12.2			14.0	12.1			14.4	12.0			30.0
32.0		11.4			10.5	11.3			12.3	11.2			12.8	11.1			32.0
34.0		10.6	10.6		8.9/32.8m	10.5	9.8/35.8m		10.3	10.4			11.4	10.3			34.0
36.0		9.9	9.9			9.8	9.7		7.8/35.8m	9.7			10.0	9.6			36.0
38.0		9.5/37.3m	9.3			9.2	9.1			9.1	8.9		8.0	9.0	8.5/39.3m		38.0
40.0			8.8			8.7	8.6			8.6	8.4		6.9/38.7m	8.5	8.2		40.0
42.0			8.3			8.6/40.2m	8.1			8.1	7.9			8.0	7.7		42.0
44.0			7.8	7.0/44.2m			7.6			7.8/43.2m	7.4			7.5	7.2		44.0
46.0			7.7/44.4m	6.7			7.2	6.4/46.4m			7.0			7.1	6.8		46.0
48.0				6.4			6.9/47.3m	6.2			6.6	5.9/48.5m		7.1/46.1m	6.4		48.0
50.0				6.1				5.9			6.2	5.7			6.0	5.3/50.7m	50.0
52.0				5.9/51.0m				5.6			6.2/50.2m	5.4			5.7	5.2	52.0
54.0								5.3/53.9m				5.1			5.5/53.2m	4.9	54.0
56.0												4.8				4.6	56.0
58.0												4.6/56.8m				4.3	58.0
60.0																4.0/59.8m	60.0

※表中の太線で囲まれた部分は、ブーム等の強度によって定められた値です。  
ジブ長さ27.4mでの、ボールフックの使用はできません。

▶ タワー長さ45.8m (75.1tカウンタウエイト/カーボディウエイトなし)(オプション) 

(単位:t)

タワー長さm	45.8																タワー長さm					
ジブ長さm	27.4				30.5				33.5				36.6				39.6				ジブ長さm	
タワー角度	90°	80°	70°	60°	90°	80°	70°	60°	90°	80°	70°	60°	90°	80°	70°	60°	90°	80°	70°	60°	タワー角度	
10.0	25.0/10.9m				24.4/11.7m																10.0	
12.0	25.0				24.2				22.7/12.5m				21.0/13.3m								12.0	
14.0	25.0				23.8				22.3				20.8				19.3/14.1m				14.0	
16.0	24.6				23.4				21.9				20.4				18.9				16.0	
18.0	24.2				23.0				21.5				20.0				18.5				18.0	
20.0	23.8				22.6				21.1				19.6				18.1				20.0	
22.0	23.1	17.3/23.3m			22.2				20.7				19.2				17.7				22.0	
24.0	19.9	16.3			20.3	16.0/24.6m			20.3	14.8/25.9m			18.8				17.3				24.0	
26.0	17.1	14.8			17.7	14.7			18.0	14.6			18.3	13.8/27.2m			16.9				26.0	
28.0	14.1	13.4			15.5	13.3			15.9	13.2			16.2	13.1			16.5	12.9/28.5m			28.0	
30.0	10.2/29.9m	12.3			13.4	12.2			14.0	12.1			14.4	12.0			14.6	11.9			30.0	
32.0		11.4			10.5	11.3			12.3	11.2			12.8	11.1			13.0	11.0			32.0	
34.0		10.6	10.2/35.0m		8.9/32.8m	10.5			10.3	10.4			11.4	10.3			11.7	10.2			34.0	
36.0		9.9	9.9			9.8	9.5/36.8m		7.8/35.8m	9.7			10.0	9.6			10.5	9.5			36.0	
38.0		9.3/37.8m	9.3			9.2	9.1			9.1	8.5/38.5m		8.0	9.0			9.4	8.9			38.0	
40.0			8.8			8.7	8.6			8.6	8.4		6.9/38.7m	8.5	8.2/40.3m		8.0	8.4			40.0	
42.0			8.3			8.4/40.7m	8.1			8.1	7.9			8.0	7.7		6.1/41.7m	7.9	7.6		42.0	
44.0			7.8	6.6/45.8m			7.6			7.8/43.7m	7.4			7.5	7.2			7.4	7.1		44.0	
46.0			7.5/45.4m	6.5			7.2	6.1/47.9m			7.0			7.1	6.8			7.0	6.7		46.0	
48.0				6.2			6.8	6.1			6.6			7.0/46.6m	6.4			6.6	6.3		48.0	
50.0				5.9			6.7/48.3m	5.8			6.2	5.5/50.1m		6.0			6.4/49.6m	5.9			50.0	
52.0				5.6				5.5			6.0/51.3m	5.3		5.7	5.0/52.2m			5.6			52.0	
54.0				5.5/52.5m				5.2				5.0		5.5	4.8			5.4	4.6/54.4m		54.0	
56.0								4.9/55.4m				4.8		5.4/54.2m	4.6				5.1	4.4	56.0	
58.0												4.5					4.4		4.8/57.2m	4.2	58.0	
60.0												4.4/58.4m					4.2			4.0	60.0	
62.0																	4.0/61.3m				62.0	
64.0																					64.0	
66.0																					3.5/64.3m	66.0

※表中の太線で囲まれた部分は、ブーム等の強度によって定められた値です。  
ジブ長さ27.4mでの、ボールフックの使用はできません。

▶ タワー長さ48.8m (75.1tカウンタウエイト/カーボディウエイトなし)(オプション)

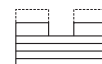

(単位:t)

タワー長さm	48.8												タワー長さm
ジブ長さm	27.4				30.5				33.5				ジブ長さm
タワー角度	90°	80°	70°	60°	90°	80°	70°	60°	90°	80°	70°	60°	タワー角度
作業半径(m)	10.0	25.0/10.9m			24.4/11.7m								10.0
	12.0	25.0			24.2				22.7/12.5m				12.0
	14.0	25.0			23.8				22.3				14.0
	16.0	24.6			23.4				21.9				16.0
	18.0	24.2			23.0				21.5				18.0
	20.0	23.8			22.6				21.1				20.0
	22.0	23.1	16.6/23.9m		22.2				20.7				22.0
	24.0	19.9	16.3		20.3	15.4/25.1m			20.3				24.0
	26.0	17.1	14.8		17.7	14.7			18.0	14.5/26.4m			26.0
	28.0	14.1	13.4		15.5	13.3			15.9	13.2			28.0
	30.0	10.2/29.9m	12.3		13.4	12.2			14.0	12.1			30.0
	32.0		11.4		10.5	11.3			12.3	11.2			32.0
	34.0		10.6		8.9/32.8m	10.5			10.3	10.4			34.0
	36.0		9.9	9.9/36.1m		9.8	9.2/37.8m		7.8/35.8m	9.7			36.0
	38.0		9.3	9.3		9.2	9.1			9.1	8.5/39.6m		38.0
	40.0		9.2/38.3m	8.8		8.7	8.6			8.6	8.4		40.0
	42.0			8.3		8.4/41.3m	8.1			8.1	7.9		42.0
	44.0			7.8			7.6			7.6	7.4		44.0
	46.0			7.4	5.9/47.3m		7.2			7.5/44.2m	7.0		46.0
	48.0			7.3/46.4m	5.9		6.8	5.3/49.4m			6.6		48.0
50.0				5.6		6.5/49.4m	5.2			6.2	5.0/51.6m	50.0	
52.0				5.3			5.0			5.9	4.9	52.0	
54.0				5.0			4.8			5.8/52.3m	4.7	54.0	
56.0							4.6				4.5	56.0	
58.0							4.5/56.9m				4.3	58.0	
60.0											4.1/59.9m	60.0	

※表中の太線で囲まれた部分は、ブーム等の強度によって定められた値です。  
ジブ長さ27.4mでの、ボールフックの使用はできません。

(単位:t)

タワー長さm	48.8												タワー長さm
ジブ長さm	36.6				39.6				42.7				ジブ長さm
タワー角度	90°	80°	70°	60°	90°	80°	70°	60°	90°	80°	70°	60°	タワー角度
作業半径(m)	12.0	21.0/13.3m											12.0
	14.0	20.8			19.3/14.1m				17.7/14.9m				14.0
	16.0	20.4			18.9				17.3				16.0
	18.0	20.0			18.5				16.9				18.0
	20.0	19.6			18.1				16.5				20.0
	22.0	19.2			17.7				16.1				22.0
	24.0	18.8			17.3				15.7				24.0
	26.0	18.3	13.4/27.7m		16.9				15.3				26.0
	28.0	16.2	13.1		16.5	12.5/29.0m			14.9				28.0
	30.0	14.4	12.0		14.6	11.9			14.5	11.8/30.3m			30.0
	32.0	12.8	11.1		13.0	11.0			13.1	10.9			32.0
	34.0	11.4	10.3		11.7	10.2			11.8	10.1			34.0
	36.0	10.0	9.6		10.5	9.5			10.6	9.4			36.0
	38.0	8.0	9.0		9.4	8.9			9.5	8.8			38.0
	40.0	6.9/38.7m	8.5	7.9/41.3m		8.0	8.4		8.6	8.3			40.0
	42.0		8.0	7.7		6.1/41.7m	7.9	7.3/43.1m		7.6	7.8		42.0
	44.0		7.5	7.2			7.4	7.1		6.1	7.3	6.8/44.8m	44.0
	46.0		7.1	6.8			7.0	6.7		5.3/44.6m	6.9	6.6	46.0
	48.0		6.8/47.2m	6.4			6.6	6.3			6.5	6.2	48.0
	50.0			6.0			6.3	5.9			6.2	5.8	50.0
52.0			5.7	4.6/53.7m		6.3/50.1m	5.6			5.9	5.5	52.0	
54.0			5.5	4.6			5.4	4.3/55.9m		5.8/53.0m	5.3	54.0	
56.0			5.3/55.3m	4.4			5.1	4.3			5.0	56.0	
58.0				4.2			4.8	4.1			4.7	4.0/58.1m	58.0
60.0				4.0			4.8/58.2m	3.9			4.5	3.8	60.0
62.0				3.8				3.7			4.3/61.2m	3.6	62.0
64.0				3.7/62.8m				3.5				3.4	64.0
66.0								3.3/65.8m				3.2	66.0
68.0												3.0	68.0
70.0												2.9/68.7m	70.0

※表中の太線で囲まれた部分は、ブーム等の強度によって定められた値です。

▶ タワー長さ51.9m (75.1tカウンタウエイト/カーボディウエイトなし)(オプション)



(単位:t)

タワー長さm	51.9																タワー長さm
ジブ長さm	27.4				30.5				33.5				36.6				ジブ長さm
タワー角度	90°	80°	70°	60°	90°	80°	70°	60°	90°	80°	70°	60°	90°	80°	70°	60°	タワー角度
作業半径(m)	10.0	25.0/10.9m			24.4/11.7m												10.0
	12.0	25.0			24.2												12.0
	14.0	25.0			23.8												14.0
	16.0	24.6			23.4												16.0
	18.0	24.2			23.0												18.0
	20.0	23.8			22.6												20.0
	22.0	23.1			22.2												22.0
	24.0	19.9	16.2/24.4m		20.3	15.1/25.7m											24.0
	26.0	17.1	14.8		17.7	14.7											26.0
	28.0	14.1	13.4		15.5	13.3											28.0
	30.0	10.2/29.9m	12.3		13.4	12.2											30.0
	32.0		11.4		10.5	11.3											32.0
	34.0		10.6		8.9/32.8m	10.5											34.0
	36.0		9.9	9.6/37.1m		9.8											36.0
	38.0		9.3	9.3		9.2	8.9/38.9m										38.0
	40.0		8.8/38.9m	8.8		8.7	8.6										40.0
	42.0			8.3		8.3/41.8m	8.1										42.0
	44.0			7.8			7.6										44.0
	46.0			7.4			7.2										46.0
	48.0			7.1/47.5m	5.4/48.8m		6.8										48.0
	50.0				5.3		6.4	4.9/51.0m									50.0
52.0				5.1		6.3/50.4m	4.8									52.0	
54.0				4.9			4.6									54.0	
56.0				4.7/55.5m			4.4									56.0	
58.0							4.2									58.0	
60.0							4.1/58.5m									60.0	
62.0																62.0	
64.0																64.0	
66.0																66.0	

※表中の太線で囲まれた部分は、ブーム等の強度によって定められた値です。  
ジブ長さ27.4mでの、ボールフックの使用はできません。

(単位:t)

タワー長さm	51.9												タワー長さm
ジブ長さm	39.6				42.7				45.7				ジブ長さm
タワー角度	90°	80°	70°	60°	90°	80°	70°	60°	90°	80°	70°	60°	タワー角度
作業半径(m)	14.0	19.3/14.1m			17.7/14.9m				15.6/15.7m				14.0
	16.0	18.9			17.3				15.5				16.0
	18.0	18.5			16.9				15.1				18.0
	20.0	18.1			16.5				14.7				20.0
	22.0	17.7			16.1				14.3				22.0
	24.0	17.3			15.7				13.9				24.0
	26.0	16.9			15.3				13.5				26.0
	28.0	16.5	12.2/29.5m		14.9				13.1				28.0
	30.0	14.6	11.9		14.5	11.5/30.8m			12.7				30.0
	32.0	13.0	11.0		13.1	10.9			12.3	10.8/32.1m			32.0
	34.0	11.7	10.2		11.8	10.1			11.9	10.0			34.0
	36.0	10.5	9.5		10.6	9.4			10.7	9.3			36.0
	38.0	9.4	8.9		9.5	8.8			9.7	8.7			38.0
	40.0	8.0	8.4		8.6	8.3			8.8	8.2			40.0
	42.0	6.1/41.7m	7.9		7.6	7.8			7.9	7.7			42.0
	44.0		7.4	7.1/44.1m	6.1	7.3	6.7/45.9m		7.1	7.2			44.0
	46.0		7.0	6.7	5.3/44.6m	6.9	6.6		6.1	6.8	6.2/47.6m		46.0
	48.0		6.6	6.3		6.5	6.2		4.7/47.5m	6.4	6.1		48.0
	50.0		6.3	5.9		6.2	5.8			6.1	5.7		50.0
	52.0		6.2/50.6m	5.6		5.9	5.5			5.8	5.5		52.0
	54.0			5.4		5.7/53.6m	5.3			5.5	5.2		54.0
56.0			5.1	3.9/57.4m		5.0			5.2	4.9		56.0	
58.0			4.8	3.8		4.7	3.5/59.6m		5.1/56.5m	4.6		58.0	
60.0			4.6/59.3m	3.6		4.5	3.4			4.4	3.0/61.7m	60.0	
62.0				3.4		4.3	3.2			4.2	3.0	62.0	
64.0				3.2		4.2/62.2m	3.0			4.0	2.8	64.0	
66.0				3.0			2.8			3.9/65.2m	2.6	66.0	
68.0				2.7/67.3m			2.6				2.4	68.0	
70.0							2.4					70.0	

※表中の太線で囲まれた部分は、ブーム等の強度によって定められた値です。

▶ タワー長さ54.9m (75.1tカウンタウエイト/カーボディウエイトなし)(オプション)

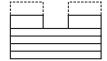

(単位:t)

タワー長さm	54.9																タワー長さm		
ジブ長さm	27.4				30.5				33.5				36.6				ジブ長さm		
タワー角度	90°	80°	70°	60°	90°	80°	70°	60°	90°	80°	70°	60°	90°	80°	70°	60°	タワー角度		
10.0	25.0/10.9m				24.4/11.7m												10.0		
12.0	25.0				24.2							22.7/12.5m				21.0/13.3m	12.0		
14.0	25.0				23.8							22.3				20.8	14.0		
16.0	24.6				23.4							21.9				20.4	16.0		
18.0	24.2				23.0							21.5				20.0	18.0		
20.0	23.8				22.6							21.1				19.6	20.0		
22.0	23.1				22.2							20.7				19.2	22.0		
24.0	19.9	15.6/24.9m			20.3							20.3				18.8	24.0		
26.0	17.1	14.8			17.7	14.7/26.2m						18.0	13.7/27.5m			18.3	26.0		
28.0	14.1	13.4			15.5	13.3						15.9	13.2			16.2	12.8/28.8m	28.0	
30.0	10.2/29.9m	12.3			13.4	12.2						14.0	12.1			14.4	12.0	30.0	
32.0		11.4			10.5	11.3						12.3	11.2			12.8	11.1	32.0	
34.0		10.6			8.9/32.8m	10.5						10.3	10.4			11.4	10.3	34.0	
36.0		9.9				9.8						7.8/35.8m	9.7			10.0	9.6	36.0	
38.0		9.3	9.3/38.2m			9.2	8.9/39.9m					9.1				8.0	9.0	38.0	
40.0		8.9/39.4m	8.8			8.7	8.6					8.6	8.0/41.7m			6.9/38.7m	8.5	40.0	
42.0			8.3			8.2	8.1					8.1	7.9			8.0	7.4/43.4m	42.0	
44.0			7.8			8.0/42.3m	7.6					7.6	7.4			7.5	7.2	44.0	
46.0			7.4				7.2					7.3/45.3m	7.0			7.1	6.8	46.0	
48.0			7.0				6.8						6.6			6.7	6.4	48.0	
50.0			6.9/48.5m	5.1/50.3m			6.4						6.2			6.7/48.2m	6.0	50.0	
52.0				4.9			6.2/51.5m	4.6/52.5m					5.9				5.7	52.0	
54.0				4.7				4.4					5.7	4.2/54.6m			5.5	54.0	
56.0				4.5				4.2					5.6/54.4m	4.0			5.2	3.7/56.8m	56.0
58.0				4.4/57.0m				4.0						3.8			5.0/57.4m	3.5	58.0
60.0								3.8						3.5				3.3	60.0
62.0														3.3				3.1	62.0
64.0														3.0/62.9m				2.9	64.0
66.0																		2.7/65.9m	66.0

※表中の太線で囲まれた部分は、ブーム等の強度によって定められた値です。  
ジブ長さ27.4mでの、ボールフックの使用はできません。

(単位:t)

タワー長さm	54.9												タワー長さm				
ジブ長さm	39.6				42.7				45.7				48.8				ジブ長さm
タワー角度	90°	80°	70°	60°	90°	80°	70°	60°	90°	80°	70°	60°	90°	80°	70°	60°	タワー角度
14.0	19.3/14.1m				17.7/14.9m				15.6/15.7m								14.0
16.0	18.9				17.3				15.5				13.8/16.5m				16.0
18.0	18.5				16.9				15.1				13.4				18.0
20.0	18.1				16.5				14.7				13.0				20.0
22.0	17.7				16.1				14.3				12.6				22.0
24.0	17.3				15.7				13.9				12.2				24.0
26.0	16.9				15.3				13.5				11.8				26.0
28.0	16.5				14.9				13.1				11.4				28.0
30.0	14.6	11.9/30.1m			14.5	11.5/31.4m			12.7				11.0				30.0
32.0	13.0	11.0			13.1	10.9			12.3	10.7/32.6m			10.6	10.0/33.9m			32.0
34.0	11.7	10.2			11.8	10.1			11.9	10.0			10.2	9.9			34.0
36.0	10.5	9.5			10.6	9.4			10.7	9.3			9.8	9.2			36.0
38.0	9.4	8.9			9.5	8.8			9.7	8.7			9.4	8.6			38.0
40.0	8.0	8.4			8.6	8.3			8.8	8.2			8.9	8.1			40.0
42.0	6.1/41.7m	7.9			7.6	7.8			7.9	7.7			8.0	7.6			42.0
44.0		7.4	6.9/45.2m		6.1	7.3			7.1	7.2			7.3	7.1			44.0
46.0		7.0	6.7		5.3/44.6m	6.9	6.3/46.9m		6.1	6.8			6.6	6.7			46.0
48.0		6.6	6.3			6.5	6.2	4.7/47.5m	6.4	6.0/48.7m			5.8	6.3			48.0
50.0		6.3	5.9			6.2	5.8		6.1	5.7			4.7	6.0	5.6/50.4m		50.0
52.0		6.2/51.2m	5.6			5.9	5.5		5.8	5.4	4.1/50.5m		5.7	5.3			52.0
54.0			5.4			5.6	5.3		5.5	5.2			5.4	5.0			54.0
56.0			5.1			5.6/54.1m	5.0		5.2	4.9			5.1	4.7			56.0
58.0			4.8	3.2/58.9m			4.7		5.0/57.0m	4.6			4.9	4.4			58.0
60.0			4.6	3.1			4.5			4.4			4.6	4.2			60.0
62.0			4.5/60.3m	2.9			4.3			4.2				3.9			62.0
64.0				2.7			4.1/63.3m			4.0				3.7			64.0
66.0				2.5						3.8				3.5			66.0
68.0										3.7/66.2m				3.3			68.0
70.0														3.3/69.1m			70.0

※表中の太線で囲まれた部分は、ブーム等の強度によって定められた値です。

▶ タワー長さ58.0m (75.1tカウンタウエイト/カーボディウエイトなし)(オプション)



(単位:t)

タワー長さm	58.0																		タワー長さm
ジブ長さm	27.4				30.5				33.5			36.6			39.6			ジブ長さm	
タワー角度	90°	80°	70°	60°	90°	80°	70°	60°	90°	80°	70°	90°	80°	70°	90°	80°	70°	タワー角度	
10.0	25.0/10.9m				24.4/11.7m													10.0	
12.0	25.0				24.2						22.7/12.5m			21.0/13.3m				12.0	
14.0	25.0				23.8						22.3			20.8			19.3/14.1m	14.0	
16.0	24.6				23.4						21.9			20.4			18.9	16.0	
18.0	24.2				23.0						21.5			20.0			18.5	18.0	
20.0	23.8				22.6						21.1			19.6			18.1	20.0	
22.0	23.1				22.2						20.7			19.2			17.7	22.0	
24.0	19.9	15.3/25.4m			20.3						20.3			18.8			17.3	24.0	
26.0	17.1	14.8			17.7	14.4/26.7m					18.0			18.3			16.9	26.0	
28.0	14.1	13.4			15.5	13.3					15.9	13.2		16.2	12.5/29.3m		16.5	28.0	
30.0	10.2/29.9m	12.3			13.4	12.2					14.0	12.1		14.4	12.0		14.6	30.0	
32.0		11.4			10.5	11.3					12.3	11.2		12.8	11.1		13.0	32.0	
34.0		10.6			8.9/32.8m	10.5					10.3	10.4		11.4	10.3		11.7	34.0	
36.0		9.9				9.8					7.8/35.8m	9.7		10.0	9.6		10.5	36.0	
38.0		9.3	9.0/39.2m			9.2					9.1			8.0	9.0		9.4	38.0	
40.0		8.7/39.9m	8.8			8.7	8.4/41.0m				8.6			6.9/38.7m	8.5		8.0	40.0	
42.0			8.3			8.2	8.1				8.1	7.8/42.7m		8.0			6.1/41.7m	42.0	
44.0			7.8			8.0/42.9m	7.6				7.6	7.4		7.5	7.1/44.5m		7.4	44.0	
46.0			7.4				7.2				7.1/45.8m	7.0		7.1	6.8		7.0	46.0	
48.0			7.0				6.8					6.6		6.7	6.4		6.6	48.0	
50.0			6.7/49.6m	4.4/51.8m			6.4					6.2		6.6/48.7m	6.0		6.3	50.0	
52.0				4.3			6.1					5.9			5.7		6.1/51.7m	52.0	
54.0				4.2			6.0/52.5m	3.8				5.7			5.5			5.4	54.0
56.0				4.0				3.6				5.4/55.5m			5.2			5.1	56.0
58.0				3.7				3.4							4.9			4.8	58.0
60.0				3.4/58.6m				3.2							4.9/58.4m			4.6	60.0
62.0								2.9/61.5m										4.5/61.3m	62.0

※表中の太線で囲まれた部分は、ブーム等の強度によって定められた値です。  
ジブ長さ27.4mでの、ボールフックの使用はできません。

(単位:t)

タワー長さm	58.0												タワー長さm
ジブ長さm	42.7			45.7			48.8			51.8			ジブ長さm
タワー角度	90°	80°	70°	90°	80°	70°	90°	80°	70°	90°	80°	70°	タワー角度
14.0	17.7/14.9m			15.5/15.7m									14.0
16.0	17.3			15.5						13.8/16.5m		11.9/17.2m	16.0
18.0	16.9			15.1						13.4		11.8	18.0
20.0	16.5			14.7						13.0		11.4	20.0
22.0	16.1			14.3						12.6		11.0	22.0
24.0	15.7			13.9						12.2		10.6	24.0
26.0	15.3			13.5						11.8		10.2	26.0
28.0	14.9			13.1						11.4		9.8	28.0
30.0	14.5	11.4/31.9m		12.7						11.0		9.4	30.0
32.0	13.1	10.9		12.3	10.4/33.2m					10.6		9.0	32.0
34.0	11.8	10.1		11.9	10.0					10.2	9.8/34.5m	8.6	34.0
36.0	10.6	9.4		10.7	9.3					9.8	9.2	8.2	36.0
38.0	9.5	8.8		9.7	8.7					9.4	8.6	7.8	38.0
40.0	8.6	8.3		8.8	8.2					8.9	8.1	7.4	40.0
42.0	7.6	7.8		7.9	7.7					8.0	7.6	7.0	42.0
44.0	6.1	7.3		7.1	7.2					7.3	7.1	6.6	44.0
46.0	5.3/44.6m	6.9		6.1	6.8					6.6	6.7	6.2	46.0
48.0		6.5	6.2	4.7/47.5m	6.4	5.8/49.7m	5.8	6.3		5.8	6.3	5.8	48.0
50.0		6.2	5.8		6.1	5.7	4.7	6.0	5.4/51.5m	5.1	5.6		50.0
52.0		5.9	5.5		5.8	5.4	4.1/50.5m	5.7	5.3	4.4	5.3	5.1/53.2m	52.0
54.0		5.6	5.3		5.5	5.2		5.4	5.0	3.8/53.4m	5.0	5.0	54.0
56.0		5.5/54.6m	5.0		5.2	4.9		5.1	4.7		4.7	4.7	56.0
58.0			4.7		5.0/57.6m	4.6		4.9	4.4		4.4	4.4	58.0
60.0			4.5			4.4		4.6	4.2		4.2	4.2	60.0
62.0			4.3			4.2		4.6/60.5m	3.9		4.0	4.0	62.0
64.0			4.1			4.0			3.7		3.8/63.5m	3.8	64.0
66.0			4.0/64.3m			3.8			3.5			3.5	66.0
68.0						3.6/67.2m			3.3			3.3	68.0
70.0									3.1			3.1	70.0
72.0									3.1/70.2m			2.9	72.0
74.0												2.5/73.1m	74.0

※表中の太線で囲まれた部分は、ブーム等の強度によって定められた値です。