

▶定格総荷重

- 定格総荷重とは、水平堅土上における転倒荷重の78%以内で、フックブロック、玉掛用ワイヤロープ等のつり具の質量を含んだ値です。
- 作業半径とはクレーン旋回中心よりつり上荷重の重心までの水平距離を意味します。
- 実際につり上げ得る荷重は定格総荷重から（主フック+玉掛用ワイヤロープ等のつり具）の質量を差し引いた値になります。
- 定格総荷重をつる場合にも風の影響、地盤の状態、作業速度その他安全作業に有害な状況がある時はオペレータは荷重の軽減、作業速度を遅くするなど状況に応じた判断をする責任があります。
- 表中の空欄の個所では作業を行うことができません。
- クレーン作業中はガントリを最高位置に立ててください。
- ラフティングタワー作業時には、タワー専用追加カウンタウエイト (0.7t) が必要です。

- すべてのタワー（ジブ）長さにおける中間タワーブーム（ジブ）の構成は取扱説明書の指示を厳守してください。
- ジブ長さ18.8mにはボールフックの使用はできません。
- 下記の仕様ではタワー自立および降下の際にクローラの前端に敷板（ブロック）を敷いてください。
※タワー長さ 41.2m (135) および44.3m (145)
- △操作ミスなどによるつり荷の落下を防ぐため、クレーン作業では自由降下（フリーフォール）作業は行わないでください。

- 巻上げロープ巻掛本数に対する最大巻上荷重とフックの質量

フック呼称		35t	ボールフック
最大巻上荷重 (t)	1本掛	11.0	11.0
	2本掛	15.0	—
フック質量		0.70t	0.30t

▶タワー長さ 26.0m

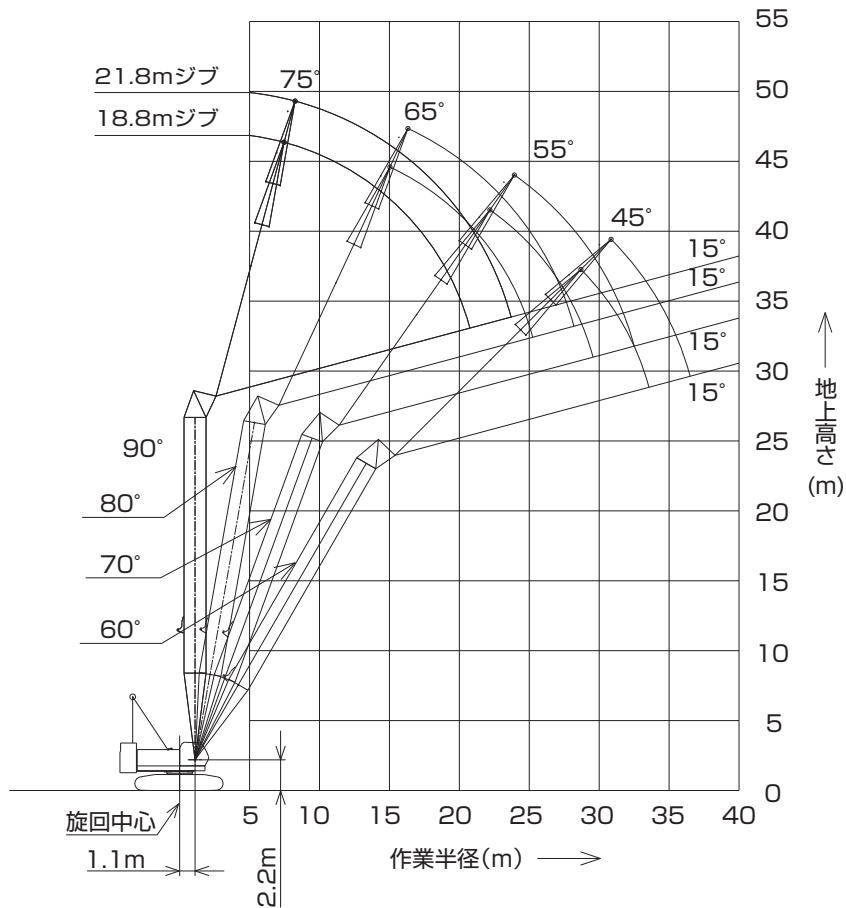

(単位:t)

タワー長さm	26.0								タワー長さm
ジブ長さm	18.8				21.8				ジブ長さm
タワー角度	90°	80°	70°	60°	90°	80°	70°	60°	タワー角度
作業半径 (m)	7.7	15.0							7.7
	8.0	15.0			15.0/8.5m				8.0
	9.0	15.0			15.0				9.0
	10.0	15.0			15.0				10.0
	12.0	15.0			15.0				12.0
	14.0	15.0	15.0/15.2m		15.0				14.0
	16.0	13.7	14.9		13.7	14.2/16.5m			16.0
	18.0	11.9	12.9		11.8	12.8			18.0
	20.0	10.6	11.4		10.4	11.2			20.0
	22.0	9.3/20.5m	10.1	8.8/22.3m	9.2	10.0			22.0
	24.0		9.1	8.0	7.8/23.4m	9.0	7.9		24.0
	26.0		8.5/24.9m	7.4		8.1	7.2		26.0
	28.0			6.7	5.6/28.7m	7.4/27.9m	6.6		28.0
	30.0			6.2/29.3m	5.4		6.1	5.0/30.8m	30.0
	32.0				5.0		5.6	4.8	32.0
	34.0				4.7/33.3m		5.5/32.2m	4.5	34.0
	36.0							4.2	36.0
38.0							4.1/36.2m	38.0	

※表中の太線で囲まれた部分は、ブーム等の強度によって定められた値です。

▶タワー長さ 29.1m

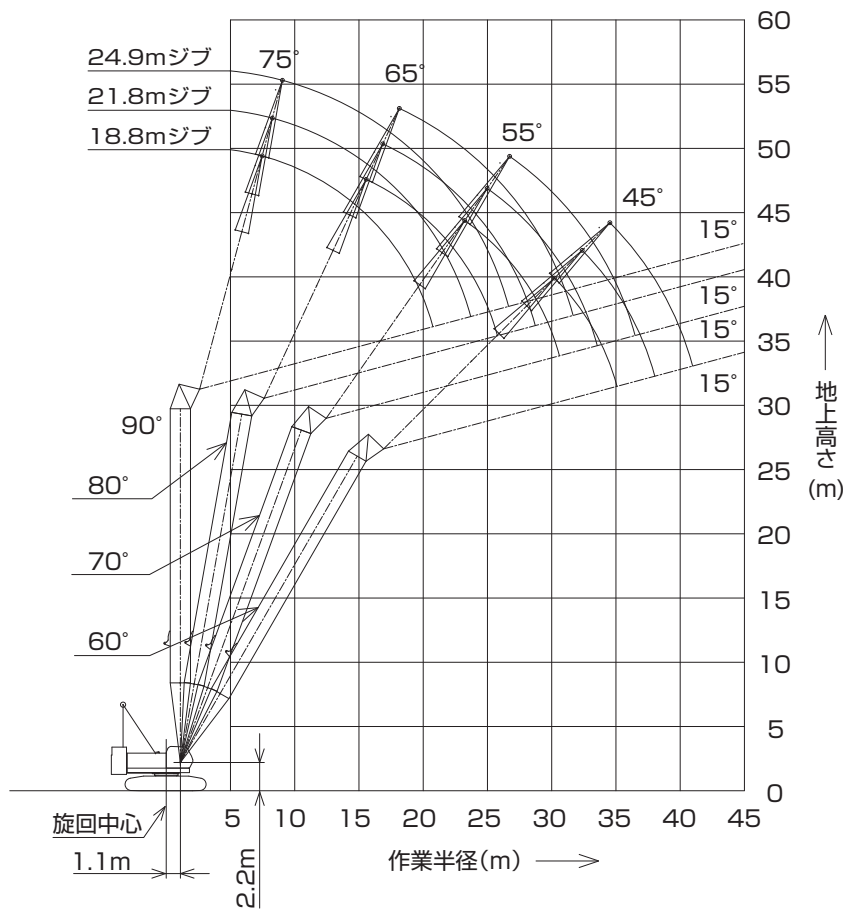

(単位:t)

タワー長さm	29.1												タワー長さm
ジブ長さm	18.8				21.8				24.9				ジブ長さm
タワー角度	90°	80°	70°	60°	90°	80°	70°	60°	90°	80°	70°	60°	タワー角度
作業半径(m)	7.7	15.0											7.7
	8.0	15.0			15.0/8.5m								8.0
	9.0	15.0			15.0				15.0/9.3m				9.0
	10.0	15.0			15.0				15.0				10.0
	12.0	15.0			15.0				15.0				12.0
	14.0	15.0	14.9/15.7m		15.0				15.0				14.0
	16.0	13.7	14.7		13.7	13.4/17.0m			13.6				16.0
	18.0	11.9	12.7		11.8	12.6			11.8	12.1/18.3m			18.0
	20.0	10.4	11.2		10.4	11.0			10.3	10.9			20.0
	22.0	9.4/20.5m	9.9	7.9/23.3m	9.2	9.8			9.2	9.8			22.0
	24.0		8.9	7.7	8.0/23.4m	8.8	7.1/25.0m		8.3	8.8			24.0
	26.0		8.1/25.5m	7.1		8.0	6.8		7.5	8.0	6.4/26.8m		26.0
	28.0			6.4		7.3	6.3		6.9/26.3m	7.3	6.1		28.0
	30.0			5.9	4.9/30.2m		7.0/28.4m	5.8		6.7	5.7		30.0
	32.0			5.7/30.3m	4.6			5.3	4.3/32.3m		6.1/31.4m	5.3	32.0
	34.0				4.3			5.0/33.2m	4.1		4.9	3.9/34.5m	34.0
	36.0				4.1/34.8m				3.9		4.5	3.7	36.0
	38.0								3.6/37.7m		4.4/36.2m	3.5	38.0
40.0											3.3	40.0	
42.0												3.2/40.7m	42.0

※表中の太線で囲まれた部分は、ブーム等の強度によって定められた値です。

■タワー長さ 32.1m

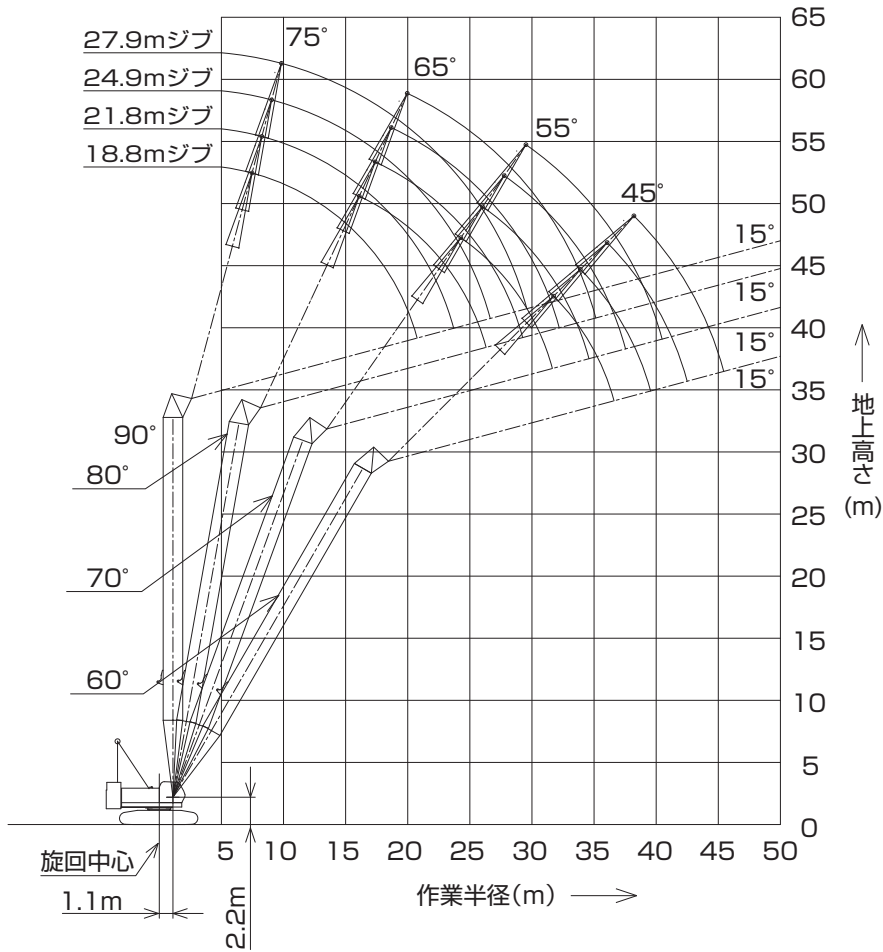

(単位:t)

タワー長さm	32.1																タワー長さm
ジブ長さm	18.8				21.8				24.9				27.9				ジブ長さm
タワー角度	90°	80°	70°	60°	90°	80°	70°	60°	90°	80°	70°	60°	90°	80°	70°	60°	タワー角度
作業半径 (m)	7.7	15.0															7.7
	8.0	15.0			15.0/8.5m												8.0
	9.0	15.0			15.0				15.0/9.3m								9.0
	10.0	15.0			15.0				15.0				15.0/10.1m				10.0
	12.0	15.0			15.0				15.0				15.0				12.0
	14.0	15.0			15.0				15.0				15.0				14.0
	16.0	13.8	14.0/16.3m		13.7	12.6/17.6m			13.7				13.6				16.0
	18.0	11.9	12.4		11.9	12.3			11.8	11.5/18.9m			11.7				18.0
	20.0	10.4	10.9		10.4	10.8			10.4	10.7			10.3	10.5/20.1m			20.0
	22.0	9.6/20.5m	9.7		9.2	9.6			9.2	9.6			9.1	9.4			22.0
	24.0		8.7	7.1/24.3m	8.1/23.4m	8.6			8.3	8.7			8.2	8.6			24.0
	26.0		7.9	6.6		7.8	6.4/26.1m		7.5	7.8	5.8/27.8m		7.4	7.7			26.0
	28.0			6.1		7.1	5.9		7.0/26.3m	7.2	5.8		6.8	7.1	5.3/29.6m		28.0
	30.0			5.6	4.3/31.7m	6.7/29.0m	5.5			6.6	5.4		6.0/29.3m	6.5	5.2		30.0
	32.0			5.2/31.3m	4.3		5.1	3.7/33.9m		6.0/31.9m	5.0			6.0	4.9		32.0
	34.0				3.9		4.7	3.7			4.6			5.5	4.5		34.0
	36.0				3.6		4.6/34.3m	3.5			4.3	3.4		5.3/34.8m	4.2		36.0
	38.0				3.5/36.3m			3.3			4.0/37.2m	3.2			3.9	3.0/38.2m	38.0
	40.0							3.1/39.9m				3.0			3.6	2.9	40.0
	42.0											2.8			3.5/40.2m	2.7	42.0
44.0												2.6/42.2m			2.5	44.0	
46.0															2.2/45.1m	46.0	

※表中の太線で囲まれた部分は、ブーム等の強度によって定められた値です。

▶タワー長さ 35.2m

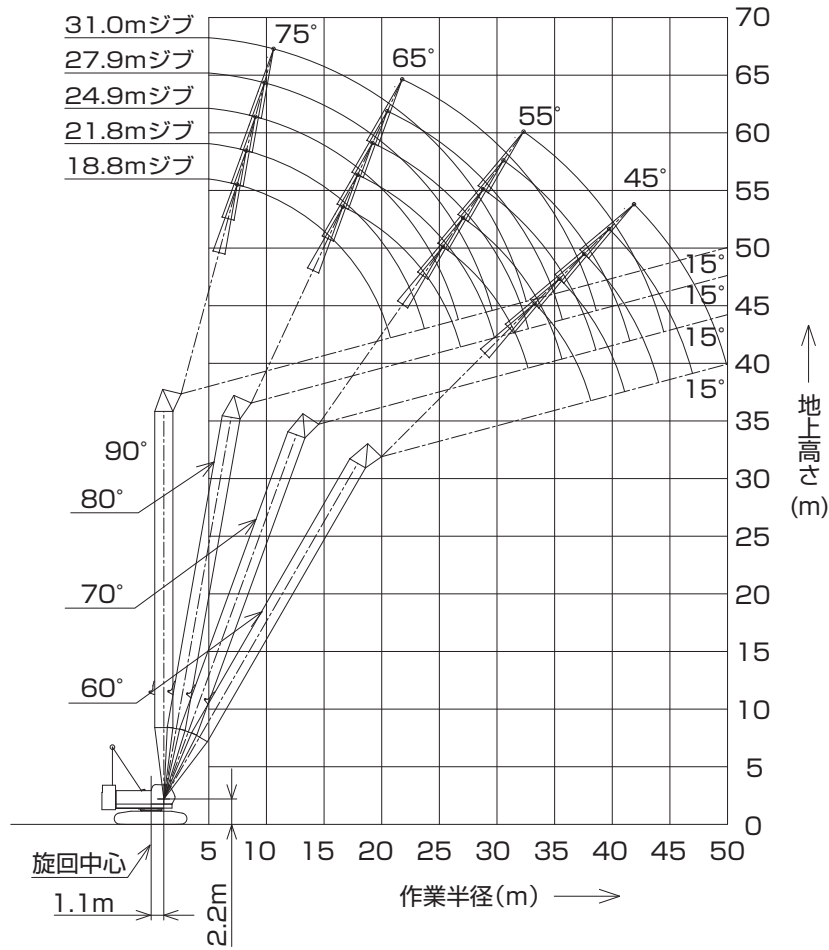

(単位:t)

タワー長さm		35.2																		タワー長さm			
ジブ長さm		18.8			21.8			24.9			27.9			31.0			ジブ長さm						
タワー角度		90°	80°	70°	60°	90°	80°	70°	60°	90°	80°	70°	60°	90°	80°	70°	60°	90°	80°	70°	60°	タワー角度	
作業半径 (m)	7.7	15.0																				7.7	
	8.0	15.0				15.0/8.5m																8.0	
	9.0	15.0				15.0				15.0/9.3m													9.0
	10.0	15.0				15.0				15.0				15.0/10.1m				13.5/10.9m					10.0
	12.0	15.0				15.0				15.0				15.0				13.5					12.0
	14.0	15.0				15.0				15.0				15.0				13.5					14.0
	16.0	13.8	13.2/16.8m			13.7				13.7				13.6				13.5					16.0
	18.0	11.9	12.2			11.9	12.0/18.1m			11.8	10.9/19.4m			11.7				11.7					18.0
	20.0	10.4	10.7			10.4	10.6			10.4	10.5			10.3	9.9/20.7m			10.2					20.0
	22.0	9.6/20.5m	9.6			9.3	9.6			9.2	9.5			9.2	9.2			9.1	9.1				22.0
	24.0		8.6	6.5/25.4m		8.2/23.4m	8.6			8.3	8.5			8.2	8.4			8.2	8.2				24.0
	26.0		7.8	6.3			7.8	5.8/27.1m		7.5	7.7			7.4	7.6			7.4	7.5				26.0
	28.0		7.4/26.5m	5.9			7.1	5.6		7.0/26.3m	7.0	5.3/28.9m		6.8	6.9			6.7	6.9				28.0
	30.0			5.4			6.4/29.5m	5.3			6.4	5.1		6.0/29.3m	6.3	4.8/30.6m		6.2	6.3				30.0
	32.0			4.9	3.6/33.2m			4.8			5.9	4.8			5.8	4.5		5.7	5.8	4.3/32.4m			32.0
	34.0				4.8/32.4m	3.6			4.5	3.2/35.4m		5.7/32.4m	4.4		5.4	4.3		5.3/32.2m	5.3	4.1			34.0
36.0					3.4			4.2/35.3m	3.2			4.1	2.9/37.5m		5.0/35.4m	4.0			5.0	3.9		36.0	
38.0						3.1/37.8m			3.0			3.8	2.9			3.7	2.5/39.7m		4.6	3.6		38.0	
40.0									2.8				3.7/38.3m	2.7		3.4	2.5		4.5/38.3m	3.4	2.1/41.9m	40.0	
42.0									2.6/40.8m					2.5			3.2/41.2m	2.3		3.1	2.1	42.0	
44.0														2.3/43.7m				2.1		2.9	1.9	44.0	
46.0																		1.9		2.9/44.2m	1.8	46.0	
48.0																			1.8/46.7m		1.7	48.0	

※表中の太線で囲まれた部分は、ブーム等の強度によって定められた値です。

■タワー長さ 38.2m

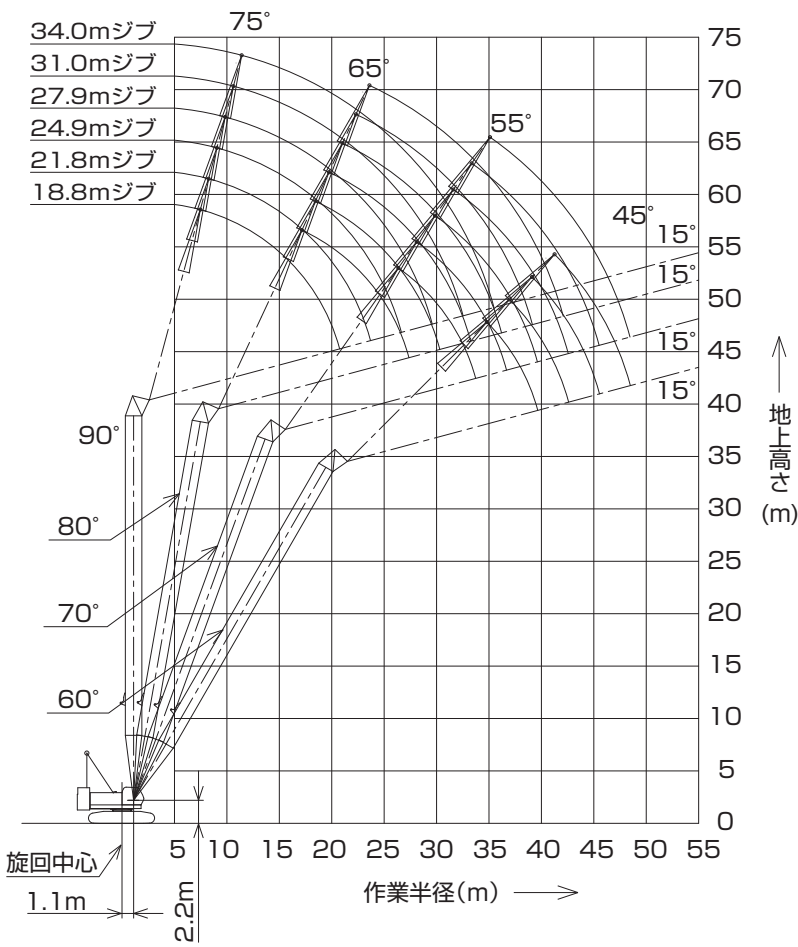

(単位:t)

タワー長さm	38.2				タワー長さm
ジブ長さm	18.8				ジブ長さm
タワー角度	90°	80°	70°	60°	タワー角度
7.7	15.0				7.7
8.0	15.0				8.0
9.0	15.0				9.0
10.0	15.0				10.0
12.0	15.0				12.0
14.0	15.0				14.0
16.0	13.8	12.5/17.3m			16.0
18.0	11.9	12.0			18.0
20.0	10.5	10.5			20.0
22.0	9.7/20.5m	9.3			22.0
24.0		8.4			24.0
26.0		7.6	5.8/26.4m		26.0
28.0		7.1/27.1m	5.4		28.0
30.0			5.1		30.0
32.0			4.7		32.0
34.0			4.3/33.4m	3.0/34.8m	34.0
36.0				2.9	36.0
38.0				2.7	38.0
40.0				2.4/39.4m	40.0
42.0					42.0
44.0					44.0
46.0					46.0
48.0					48.0
50.0					50.0

(単位:t)

タワー長さm	38.2															タワー長さm						
ジブ長さm	21.8				24.9				27.9				31.0			34.0				ジブ長さm		
タワー角度	90°	80°	70°	60°	90°	80°	70°	60°	90°	80°	70°	60°	90°	80°	70°	90°	80°	70°	タワー角度			
7.7																			7.7			
8.0	15.0/8.5m																		8.0			
9.0	15.0			15.0/9.3m															9.0			
10.0	15.0			15.0									15.0/10.1m			13.5/10.9m		11.5/11.7m	10.0			
12.0	15.0			15.0									15.0			13.5		11.5	12.0			
14.0	15.0			15.0									15.0			13.5		11.5	14.0			
16.0	13.8			13.7									13.6			13.5		11.5	16.0			
18.0	11.9	11.3/18.6m		11.8	10.3/19.9m								11.8			11.7		11.5	18.0			
20.0	10.4	10.4		10.4	10.3								10.3	9.4/21.2m		10.3		10.2	20.0			
22.0	9.3	9.3		9.2	9.2								9.2	9.0		9.1	8.6/22.5m	9.1	7.9/23.8m	22.0		
24.0	8.2/23.4m	8.4		8.3	8.3								8.2	8.2		8.2	8.0	8.1	7.9	24.0		
26.0		7.6		7.5	7.5								7.4	7.4		7.4	7.3	7.3	7.2	26.0		
28.0		6.9	5.2/28.2m	7.1/26.3m	6.9	4.8/29.9m							6.8	6.8		6.7	6.7	6.7	6.6	28.0		
30.0		6.3	4.8		6.3	4.8							6.1/29.3m	6.2	4.4/31.7m	6.2	6.1	6.1	6.0	30.0		
32.0		4.6		5.8	4.4								5.7	4.3		5.7	5.6	4.0/33.4m	5.6	5.6	32.0	
34.0		4.2		5.5/33.0m	4.1								5.3	4.0		5.6/32.2m	5.2	3.9	5.2	5.1	3.6/35.2m	34.0
36.0		3.9	2.5/36.9m		3.8								4.9/35.9m	3.7			4.8	3.6	4.6/35.2m	4.8	3.5	36.0
38.0		3.8/36.4m	2.5		3.5	2.2/39.1m							3.4			4.5	3.4		4.4	3.3	38.0	
40.0		2.3		3.3/39.3m	2.2								3.2	1.8/41.2m		4.3/38.8m	3.1		4.1	3.0	40.0	
42.0		2.1			2.0								3.0	1.8			2.9		3.8/41.8m	2.8	42.0	
44.0		1.9/42.3m			1.8								2.9/42.3m	1.5			2.7			2.6	44.0	
46.0					1.5/45.2m												2.5/45.2m			2.5	46.0	
48.0																				2.3	48.0	
50.0																				2.2/48.2m	50.0	

※表中の太線で囲まれた部分は、ブーム等の強度によって定められた値です。

▶タワー長さ 41.2m

(単位:t)

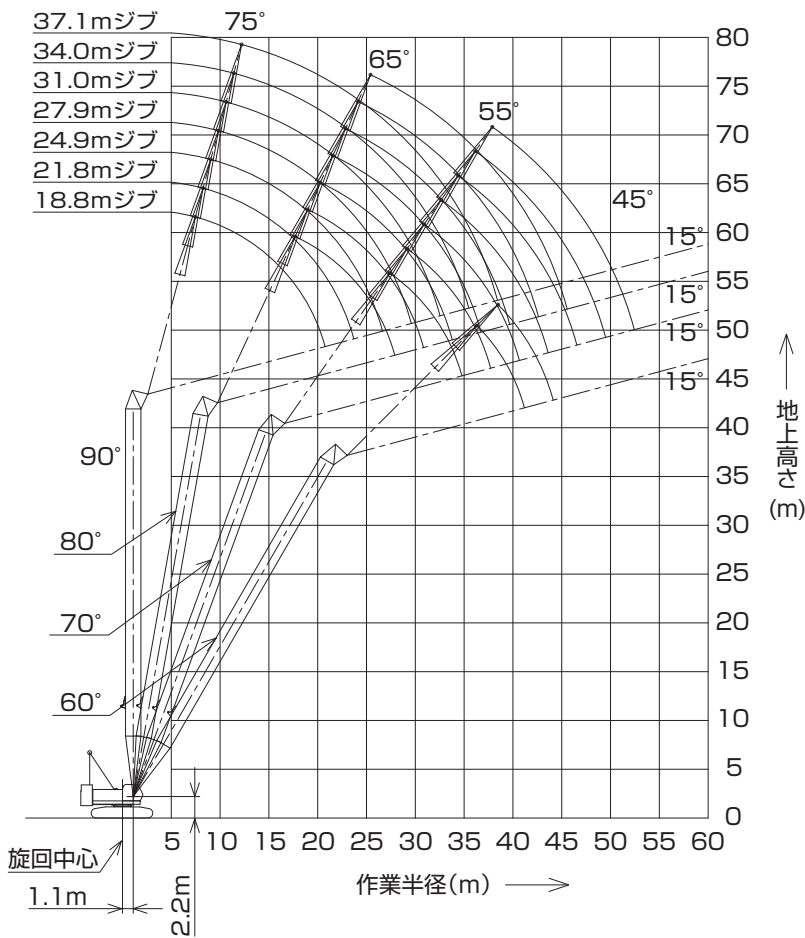

タワー長さm	41.2				タワー長さm
ジブ長さm	18.8				ジブ長さm
タワー角度	90°	80°	70°	60°	タワー角度
7.7	15.0				7.7
8.0	15.0				8.0
9.0	15.0				9.0
10.0	15.0				10.0
12.0	15.0				12.0
14.0	15.0				14.0
16.0	13.8	11.8/17.9m			16.0
18.0	11.9	11.7			18.0
20.0	10.5	10.3			20.0
22.0	9.8/20.5m	9.1			22.0
24.0		8.2			24.0
26.0		7.4	5.4/27.5m		26.0
28.0		6.7/27.6m	5.2		28.0
30.0			4.8		30.0
32.0			4.4		32.0
34.0			4.1		34.0
36.0			3.9/34.5m	2.4/36.3m	36.0
38.0				2.3	38.0
40.0				2.1	40.0
42.0				1.9/40.9m	42.0
44.0					44.0
46.0					46.0
48.0					48.0
50.0					50.0

(単位:t)

タワー長さm	41.2																		タワー長さm	
ジブ長さm	21.8				24.9			27.9			31.0			34.0			37.1			ジブ長さm
タワー角度	90°	80°	70°	60°	90°	80°	70°	90°	80°	70°	90°	80°	70°	90°	80°	70°	90°	80°	70°	タワー角度
7.7																				7.7
8.0	15.0/8.5m																			8.0
9.0	15.0				15.0/9.3m									11.5/11.7m						9.0
10.0	15.0				15.0			15.0/10.1m			13.5/10.9m			11.5						10.0
12.0	15.0				15.0			15.0			13.5			11.5			9.5/12.5m			12.0
14.0	15.0				15.0			15.0			13.5			11.5			9.5			14.0
16.0	13.8				13.7			13.6			13.5			11.5			9.5			16.0
18.0	11.9	10.7/19.2m			11.8			11.8			11.7			11.5			9.4			18.0
20.0	10.4	10.2			10.4	9.7/20.4m		10.3	8.9/21.7m		10.3			10.2			9.1			20.0
22.0	9.3	9.1			9.2	8.9		9.2	8.8		9.1	8.2/23.0m		9.1			8.7			22.0
24.0	8.3/23.4m	8.2			8.3	8.1		8.2	8.0		8.2	7.8		8.1	7.5/24.3m		8.2	7.1/25.9m		24.0
26.0		7.4			7.5	7.4		7.4	7.3		7.4	7.2		7.3	6.9		7.4	7.0		26.0
28.0		6.8	4.9/29.2m		7.1/26.3m	6.7		6.8	6.6		6.7	6.5		6.7	6.4		6.7	6.3		28.0
30.0		6.2	4.7		6.2	4.4/31.0m	6.1/29.3m	6.1			6.2	6.0		6.1	5.9		6.2	5.8		30.0
32.0		6.0/30.5m	4.3		5.7	4.2		5.6	4.0/32.7m	5.7	5.5			5.6	5.4		5.7	5.3		32.0
34.0		4.0			5.2/33.5m	3.9		5.1	3.8	3.5	5.6/32.2m	5.1	3.6/34.5m	5.2	5.0		5.2	4.9		34.0
36.0		3.7			3.6	3.6		4.8	3.5		4.7	3.4	4.6/35.2m	4.6	3.3/36.2m	4.9	4.5			36.0
38.0		3.4/37.4m	2.0/38.4m		3.3	3.3		4.6/36.4m	3.2		4.4	3.1		4.3	3.0	4.5	4.2	2.9/38.4m		38.0
40.0			1.9		3.1	3.1		3.0	3.0		4.1/39.4m	2.9		4.0	2.8	4.4/38.1m	3.9	2.7		40.0
42.0			1.7		3.0/40.4m	2.8		2.8	2.8		2.7	2.7		3.7	2.6		3.7	2.4		42.0
44.0			1.6/43.8m								2.5	2.5		3.7/42.3m	2.4		3.4	2.2		44.0
46.0														2.3			3.2/45.3m	2.1		46.0
48.0														2.2/46.2m			2.0			48.0
50.0																1.9/49.2m			1.7	50.0
52.0																			1.6	52.0

※表中の太線で囲まれた部分は、ブーム等の強度によって定められた値です。

■タワー長さ 44.3m

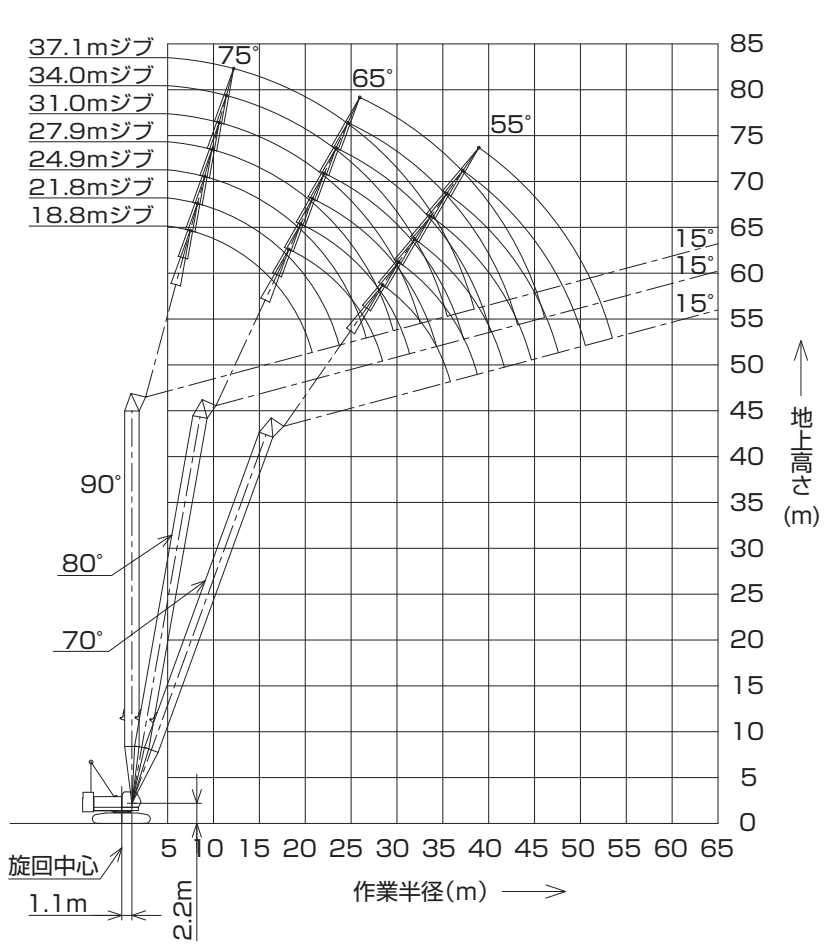

(単位:t)

タワー長さm	44.3			タワー長さm
ジブ長さm	18.8			ジブ長さm
タワー角度	90°	80°	70°	タワー角度
7.7	15.0			7.7
8.0	15.0			8.0
9.0	15.0			9.0
10.0	15.0			10.0
12.0	15.0			12.0
14.0	15.0			14.0
16.0	13.8			16.0
18.0	11.9	11.1/18.4m		18.0
20.0	10.5	10.1		20.0
22.0	9.8/20.5m	9.1		22.0
24.0		8.1		24.0
26.0		7.4		26.0
28.0		6.7	4.8/28.5m	28.0
30.0		6.6/28.1m	4.5	30.0
32.0			4.2	32.0
34.0			3.8	34.0
36.0			3.5/35.5m	36.0
38.0				38.0
40.0				40.0
42.0				42.0
44.0				44.0
46.0				46.0
48.0				48.0
50.0				50.0

(単位:t)

タワー長さm	44.3																		タワー長さm
ジブ長さm	21.8			24.9			27.9			31.0			34.0			37.1			ジブ長さm
タワー角度	90°	80°	70°	90°	80°	70°	90°	80°	70°	90°	80°	70°	90°	80°	70°	90°	80°	70°	タワー角度
7.7																			7.7
8.0	15.0/8.5m																		8.0
9.0	15.0			15.0/9.3m															9.0
10.0	15.0			15.0			15.0/10.1m			13.5/10.9m			11.5/11.7m						10.0
12.0	15.0			15.0			15.0			13.5			11.5			9.5/12.5m			12.0
14.0	15.0			15.0			15.0			13.5			11.5			9.5			14.0
16.0	13.8			13.7			13.6			13.5			11.5			9.5			16.0
18.0	11.9	10.1/19.7m		11.9			11.8			11.7			11.5			9.4			18.0
20.0	10.4	9.9		10.4	9.2/21.0m		10.3			10.3			10.2			9.0			20.0
22.0	9.3	8.9		9.2	8.7		9.2	8.4/22.3m		9.1	7.8/23.5m		9.1			8.7			22.0
24.0	8.3/23.4m	8.0		8.3	7.9		8.2	7.7		8.2	7.6		8.1	7.1/24.8m		8.2			24.0
26.0		7.3		7.5	7.2		7.5	7.1		7.4	7.0		7.3	6.7		7.4	6.7/26.5m		26.0
28.0		6.6		7.1/26.3m	6.6		6.8	6.4		6.7	6.4		6.7	6.3		6.7	6.2		28.0
30.0		6.1	4.3/30.3m		6.0		6.1/29.3m	5.9		6.2	5.8		6.1	5.7		6.2	5.6		30.0
32.0		5.7/31.1m	4.0		5.5	3.9		5.4	3.5/33.8m	5.7	5.4		5.6	5.3		5.7	5.2		32.0
34.0			3.7		5.1	3.6		5.0	3.5	5.6/32.2m	5.0	3.2/35.5m	5.2	4.9		5.3	4.8		34.0
36.0			3.4			3.4		4.6	3.2		4.6	3.1	4.7/35.2m	4.5	2.8/37.3m	4.9	4.4		36.0
38.0			3.2			3.1		4.4/37.0m	3.0		4.3	2.9		4.2	2.7	4.5	4.1	2.4/39.4m	38.0
40.0			3.1/38.5m			2.9			2.8		4.0/39.9m	2.7		3.9	2.5	4.4/38.1m	3.8	2.3	40.0
42.0						2.5/41.4m			2.6			2.4		3.6	2.3		3.6	2.1	42.0
44.0									2.3			2.2		3.5/42.8m	2.1		3.3	2.0	44.0
46.0									2.1/44.3m			2.1			2.0		3.1/45.8m	1.8	46.0
48.0												1.8/47.3m			1.8			1.6	48.0
50.0															1.6				50.0

※表中の太線で囲まれた部分は、ブーム等の強度によって定められた値です。

アタッチメント (オプション)

▶ クラムセル

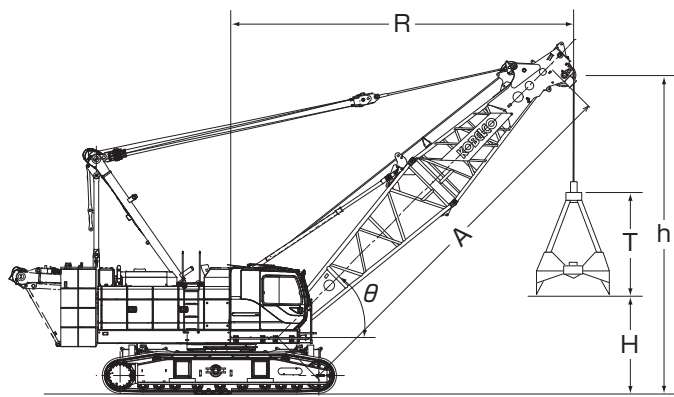

バケット 高さ 開口時	バケット 容量	1.6m³	T	3.6m
		2.0m³		3.9m
		2.5m³		4.3m
		3.0m³		4.5m

〈注〉

- ①バケットの単体質量は5.5tを超えてはいけません。
- ②バケットと掘削物の合計質量が定格総荷重を超えてはいけません。
- ③掘削物に応じて、次式により最適なバケットをお選びください。
 バケット容量 (m³) × 掘削物比重 (t/m³) + バケット質量 (t) ≤ 定格総荷重 (t)
 掘削物：砂、砂利、石灰石等(見掛け比重1~1.5程度)
 例)バケット容量3.0m³、バケット質量5.5tの場合
 (バケット容量) × (掘削物比重) + (バケット質量) ≤ (定格総荷重)
 3.0m³ × 1.5 + 5.5t ≤ 10.0t
- ④作業サイクル、バケットの降下高さによってはバケット質量の低減が必要です。
- ⑤定格総荷重は安定度から決まっています。旋回時にブーム横引き荷重が作用するような急加速・急減速は避けてください。特にブームが長いときは注意が必要です。

ブーム長さ		m	13.8					16.9					19.9					23.0																				
ブーム角度		度	34	41	53	63	67	31	43	52	60	64	34	44	52	59	62	37	44	51	57	63																
作業半径		m	R	13.0	12.0	10.0	8.0	7.0	16.0	14.0	12.0	10.0	9.0	18.0	16.0	14.0	12.0	11.0	20.0	18.0	16.0	14.0	12.0															
開口地上高さ m	バケット容量	1.6m³	H	2.1	3.5	5.4	6.7	7.2	3.0	5.8	7.7	9.1	9.7	5.6	8.2	10.0	11.5	12.1	8.1	10.5	12.3	13.8	15.0															
		2.0m³	1.8	3.2	5.1	6.4	6.9	2.7	5.5	7.4	8.8	9.4	5.3	7.9	9.7	11.2	11.8	7.8	10.2	12.0	13.5	14.7																
		2.5m³	1.4	2.8	4.7	6.0	6.5	2.3	5.1	7.0	8.4	9.0	4.9	7.5	9.3	10.8	11.4	7.4	9.8	11.6	13.1	14.3																
		3.0m³	1.2	2.6	4.5	5.8	6.3	2.1	4.9	6.8	8.2	8.8	4.7	7.3	9.1	10.6	11.2	7.2	9.6	11.4	12.9	14.1																
ブームポイント高さ		m	h	9.7	11.1	13.0	14.3	14.8	10.6	13.4	15.3	16.7	17.3	13.2	15.8	17.6	19.1	19.7	15.7	18.1	19.9	21.4	22.6															
定格総荷重		t		10.0										9.3					10.0					8.4					9.6					10.0				

台船搭載 (オプション)

▶クレーン

(単位:t)

ブーム長さ 作業半径(m)	13.8	16.9	19.9	23.0	26.0	29.1	32.1	35.2	38.2	ブーム長さ 作業半径(m)
4.0	60.0/4.7m									4.0
5.0	55.0	49.4/5.2m	43.5/5.9m							5.0
6.0	43.1	42.9	42.8	38.4/6.6m						6.0
7.0	36.7	36.4	36.2	36.1	34.3/7.3m	31.3/7.9m				7.0
8.0	31.8	31.5	31.4	31.2	31.0	30.9	28.2/8.6m			8.0
9.0	27.9	27.7	27.6	27.5	27.3	27.1	26.9	25.7/9.3m		9.0
10.0	23.2	24.6	24.5	24.4	24.2	24.0	23.8	23.7	23.6	10.0
12.0	16.5	18.2	19.6	19.7	19.6	19.5	19.4	19.1	19.0	12.0
14.0	13.2/13.2m	13.9	15.1	16.1	15.9	15.8	15.8	15.6	15.5	14.0
16.0		11.1/15.8m	12.0	12.9	13.3	13.2	13.1	13.0	12.8	16.0
18.0			9.7	10.5	11.1	11.3	11.2	11.0	10.9	18.0
20.0			9.1/18.5m	8.6	9.2	9.7	9.7	9.5	9.4	20.0
22.0				7.8/21.1m	7.7	8.2	8.5	8.3	8.2	22.0
24.0					6.6/23.8m	6.9	7.3	7.3	7.2	24.0
26.0						5.9	6.3	6.5	6.4	26.0
28.0						5.7/26.4m	5.4	5.6	5.7	28.0
30.0							5.0/29.0m	4.8	5.1	30.0
32.0								4.3/31.7m	4.5	32.0
34.0									3.9	34.0
36.0									3.8/34.3m	36.0

〈注〉

- ①作業半径とはクレーンの旋回中心より吊上荷重の重心までの水平距離を意味します。
- ②定格総荷重は、フックブロック、玉掛用ワイヤロープ等の吊具の重量を含んだ値です。
- ③作業時のクレーン部の傾斜角度は、水平面に対してクレーン前後方向で3°以内、クレーン左右方向で1.5°以内となるようにしてください。定格総荷重はこの条件において設定しています。
- ④上表能力はクローラを固縛した時の能力です。
- ⑤ 内の定格総荷重は強度域です。

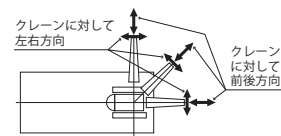

▶クラムセル

(単位:t)

ブーム長さ 作業半径(m)	13.8	16.9	19.9	23.0	ブーム長さ 作業半径(m)
7.0	10.0				7.0
8.0	10.0				8.0
9.0	10.0	10.0			9.0
10.0	10.0	10.0	10.0/11.0m		10.0
12.0	10.0	10.0	10.0	10.0	12.0
14.0	10.0/13.0m	10.0	10.0	10.0	14.0
16.0		10.0	10.0	9.5	16.0
18.0			9.1	8.5	18.0
20.0				7.5	20.0

〈注〉

- ①バケットの単体質量は5.5tを超えてはいけません。
- ②バケットと掘削物の合計質量が定格総荷重を超えてはいけません。
- ③作業半径とは荷重状態におけるクレーンの旋回中心よりバケット重心までの水平距離を意味します。
- ④旋回時にブーム横引き荷重が作用するような急加速・急減速運転、旋回投げ捨ておよび斜め引き掘削等を行わないでください。
- ⑤作業時のクレーン部の傾斜角度は、水平面に対してクレーン前後方向で3°以内、クレーン左右方向で1.5°以内となるようにしてください。定格総荷重はこの条件において設定しています。
- ⑥上表能力はクローラを固縛した時の能力です。

